



*IARU-R1 VHF Handbook*



Version 8.50 July 2019

IARU-R1

*The content of this Handbook is the property of the International Amateur Radio Union, Region 1.*

Copying and publication of the content, or parts thereof, is allowed for non-commercial purposes provided the source of information is quoted.

---

### Contact information

---

Website:	<a href="http://www.iaru-r1.org/index.php/vhfuhsshf">http://www.iaru-r1.org/index.php/vhfuhsshf</a>
Handbook:	
Newsletters:	<a href="http://www.iaru-r1.org/index.php/documents/Documents/Newsletters/VHF-Newsletters/">http://www.iaru-r1.org/index.php/documents/Documents/Newsletters/VHF-Newsletters/</a>
Wiki	<a href="http://iaruwiki.oevsv.at">http://iaruwiki.oevsv.at</a>
Contest robot	<a href="http://iaru.oevsv.at/v_upld/prg_list.php">http://iaru.oevsv.at/v_upld/prg_list.php</a>

IARU-R1

Oostende, July 15<sup>th</sup> 2019

Dear YL and OM,

During our interim meeting in Vienna 2019 we decided about the future look of the VHF Handbook. The interim meeting decided that the version 8.12 will be used as the basic division and that future improvements will be added to this version.

The Handbook consists of 5 PARTS who are covering all aspects of the VHF community:

- PART 1: IARU-R1 VHF& up Organisation
- PART 2: Bandplanning
- PART 3: Contesting
- PART 4: Technical and operational references
- PART 5: archive

This handbook is based on the last decisions made during the General Conference in Landshut 2017 (highlighted in yellow).

The recommendations made during the Interim meeting in Vienna, and approved by the EC are highlighted in green. Those recommendations need to be endorsed by the next General Conference in Novi Sad 2020.

73 de Jacques, ON4AVJ

Chairman VHF&up committee (C5) IARU-R1

# CONTENT

## PART 1: IARU-1 VHF & UP ORGANISATION

<b>1</b>	<b>ORGANISATION</b>	<b>17</b>
1.1	Constitution of the IARU Region 1 VHF/UHF/Microwaves Committee	17
1.1.1	In the Constitution:	17
1.1.2	In the Bye-laws:	17
1.1.3	Terms of reference of the IARU Region 1 VHF/UHF/Microwaves Committee	18
1.2	Tasks of IARU R-1 and its VHF/UHF/μWave Committee	19
1.3	Microwave managers Sub-committee	20
1.4	Coordinators of the VHF/UHF/Microwaves Committee	21
1.4.1	VHF Contest Coordinator	21
1.4.2	Satellite coordinator	21
1.4.3	Beacon coordinator	21
1.4.4	Propagations coordinators	21
1.4.5	Records coordinator	21
1.4.6	Repeater coordinator	21
1.5	IARU R-1 Executive Committee	21
1.6	Actual IARU-R1 VHF/UHF/SHF Chairman, Co-ordinators and co-workers	22
1.7	National VHF managers	23
1.8	MICROWAVE MANAGERS	26
1.8.1	Note.	26
<b>2</b>	<b>RECOMMENDATIONS FOR VHF MANAGERS</b>	<b>27</b>
2.1	Protect our amateur bands(Landshut 2017)	27
2.1.1	General	27
2.1.2	24 and 47 GHz band	27
2.1.3	Millimetre bands	27
2.1.4	50 MHz Band	27
2.2	Defending the bands from 1 GHz to 10 GHz (Vienna 2019)	28
2.2.1	Introduction	28
2.2.2	Actions	28
2.3	Licenced share access (LSA)	28
2.4	Band activity survey	28
2.5	Proper use of amateur frequencies (Cavtat 2008)	28
2.6	Satellite frequency coordination (Cavtat 2008)	29
2.7	145MHz for satellite downlinks (Cavtat 2008)	29

IARU-R1	
<b>2.8 Multi-Band beacon clusters (Cavtat 2008)</b>	<b>29</b>
<b>2.9 3400-3410MHz allocation</b>	<b>29</b>
<b>2.10 Contest Log exchange</b>	<b>29</b>
<b>2.11 DX code of conduct (Varna 2014)</b>	<b>29</b>
<b>2.12 TV Repeater Transmissions (Varna 2014)</b>	<b>29</b>
<b>2.13 Remote Controlled Operation (Varna 2014)</b>	<b>30</b>
<b>2.14 Information about repeaters</b>	<b>30</b>
<b>3 IARU R-1 AND IARU SATELLITE COORDINATION</b>	<b>31</b>
<b>3.1 ITU Notification Requirements for Amateur Satellites</b>	<b>31</b>
3.1.1 Background	31
3.1.2 Procedure	31
<b>3.2 IARU-AC 89-3 concerning amateur satellite usage</b>	<b>32</b>
<b>3.3 Terms of reference of the IARU satellite adviser</b>	<b>33</b>
3.3.1 General:	33
3.3.2 Function	33
3.3.3 Appointment:	33
3.3.4 Tasks:	33
<b>3.4 Terms of reference of the IARU AMSAT satellite frequency coordinator</b>	<b>34</b>
3.4.1 General	34
3.4.2 Function	34
3.4.3 Appointment	34
3.4.4 Tasks	34
<b>3.5 RELEVANT IARU REGION-1 RECOMMENDATIONS</b>	<b>35</b>
3.5.1 Recommendation CT08_C5_Rec01	35
3.5.2 Recommendation CT08_C5_Rec02	35
3.5.3 Recommendation CT08_C5_Rec22	35
3.5.4 Recommendation CT08_C5_Rec25	35
3.5.5 Recommendation CT08_C5_Rec37	35
<b>4 IARU-R1 REPEATER COORDINATION</b>	<b>36</b>
<b>4.1 Coordination of repeater activities</b>	<b>36</b>
<b>4.2 Repeater coordination: coverage presentation</b>	<b>37</b>
4.2.1 Introduction	37
4.2.2 General rules for operating via repeaters	37
4.2.3 Recommended methods to prepare coverage map	37

<b>5</b>	<b>IARU-R1 BEACON COORDINATION</b>	<b>38</b>
<b>5.1</b>	<b>IARU R1 beacons: a guide to good practice</b>	<b>38</b>
5.1.1	Coordination procedure	38
5.1.2	Local Beacons:	38
5.1.3	Transmission mode	38
5.1.4	Frequency spacing	38
<b>5.2</b>	<b>Transatlantic beacon project</b>	<b>39</b>
<b>5.3</b>	<b>Synchronised 50 MHz Beacon Project (Varna 2014)</b>	<b>40</b>
5.3.1	Introduction	40
5.3.2	50 MHz synchronised not transmitting in their timeslot	40
<b>6</b>	<b>IARU-R1 CERTIFICATES AND MEDALS</b>	<b>41</b>
<b>6.1</b>	<b>DB6NT</b>	<b>41</b>
<b>6.2</b>	<b>S53MV</b>	<b>41</b>
<b>6.3</b>	<b>National VHF/UHF/<math>\mu</math>Waves awards and certificates</b>	<b>42</b>
6.3.1	Note	42

**PART 2: BANDPLANNING**

<b>1</b>	<b>IARU REGION 1 BANDPLANS</b>	<b>44</b>
1.1	Introduction	44
1.1.1	General	44
1.1.2	European table of frequency allocations	44
1.2	50 – 54 MHz Band plan	45
1.2.1	Notes: bandplan	45
1.2.2	Notes: Usage	45
1.3	70.0 – 70.5 MHz Band plan	47
1.3.1	Notes: BANDPLAN	47
1.3.2	Notes: Usage	47
1.4	144 – 146 MHz Bandplan	48
1.4.1	Notes: BANDPLAN	49
1.4.2	Notes: Usage	50
1.4.3	National usage notes	50
1.5	430 – 440 MHz	51
1.5.1	Notes: BANDPLAN	53
1.5.2	Notes: Usage	53
1.5.3	National usage notes	54
1.5.4	DATV & SATV in the 435 MHz Band (Varna 2014)	54
1.6	1200 – 1300 MHz Bandplan	56
1.6.1	Notes: BANDPLAN	57
1.6.2	Notes: Usage	57
1.7	2300 – 2450 MHz Bandplan	58
1.7.1	Notes: BANDPLAN	58
1.8	3400 -3475 MHz	59
1.8.1	Notes: BANDPLAN	59
1.9	5650 – 5850 MHz Bandplan	60
1.9.1	Notes: BANDPLAN	60
1.10	10.000 – 10.500 GHz Bandplan	61
1.10.1	Notes: BANDPLAN	61
1.11	24.000 – 24250 GHz Bandplan	62
1.11.1	Notes: BANDPLAN	62
1.12	47.000 – 47.200 GHz Bandplan	63
1.13	75.500 – 81.500 GHz Bandplan	64
1.13.1	Notes: BANDPLAN	64
1.14	122.250 – 123.000 GHz Bandplan	65

IARU-R1

<b>1.15</b>	<b>134.000 – 141.000 GHz Bandplan</b>	<b>66</b>
1.15.1	Notes: BANDPLAN	66
<b>1.16</b>	<b>241.000 – 250.000 GHz Bandplan</b>	<b>67</b>
1.16.1	Notes: BANDPLAN	67
<b>1.17</b>	<b>Additional Band plans</b>	<b>68</b>
1.17.1	Table 1 Irish 40–44 MHz (8 metre) Band Plan for Amateur Service	68
1.17.2	Table 2 Irish 54.0–69.9 MHz (5 metre) Band Plan for Amateur Service	69

## **2 MANAGING FREQUENCY ALLOCATIONS & BAND PLANNING** **70**

<b>2.1</b>	<b>Introduction to VHF/UHF/<math>\mu</math>Waves bands and bandplans</b>	<b>70</b>
2.1.1	Amateur and Amateur Satellite Service frequency allocations above 30 MHz	70
<b>2.2</b>	<b>IARU-R1 Bandplanning: principles</b>	<b>70</b>
2.2.1	Basis	70
2.2.2	Remarks on the practical implementation	71
2.2.3	Coordination process:	72
2.2.4	Some definitions	72
<b>2.3</b>	<b>ITU and WRC Frequency Allocations Process</b>	<b>73</b>
2.3.1	List of Regional Telecommunications Organisations (RTOs)	73
<b>2.4</b>	<b>Channel designation system for VHF/UHF FM channels</b>	<b>74</b>
2.4.1	Principle	74
2.4.2	Examples	74
2.4.3	Notes:	74



**PART 3: CONTESTING**

<b>1</b>	<b>RULES IARU R1 50/70 MHZ, 145 MHZ AND UHF/<math>\mu</math>W CONTESTS</b>	<b>76</b>
1.1	Objective	76
1.2	Definitions	76
1.3	Conditions for entrants	76
1.4	Date of contests	77
1.5	Contest sections	77
1.5.1	50/70 MHz Contest:	77
1.5.2	145 MHz contest:	77
1.5.3	UHF/Microwaves Contest:	77
1.6	Operating	77
1.7	Contacts	77
1.7.1	Acceptable examples when using a secondary method:	78
1.7.2	Unacceptable examples when using a secondary method:	78
1.7.3	Definition for a valid contest QSO:	78
1.8	Type of emission	78
1.9	Contest exchanges	78
1.10	Scoring	79
1.11	Entries	79
1.12	Judging of entries	80
1.13	Awards	80
1.13.1	Section winners:	80
1.13.2	Overall winners for UHF/Microwave contest:	80
1.13.3	Millimetre group	80
<b>2</b>	<b>RULES IARU REGION I ATV CONTEST</b>	<b>81</b>
2.1	Goal	81
2.2	Terms and Definitions	81
2.3	Responsibilities	82
2.4	Contest	82

<b>3</b>	<b>PROCEDURE FOR ORGANISING IARU-R1 1 VHF/UHF/<math>\mu</math>WAVE CONTESTS</b>	<b>84</b>
<b>3.1</b>	<b>Terms of reference for the contest working group</b>	<b>84</b>
3.1.1	Objectives	84
3.1.2	Responsibilities	84
3.1.3	Group Membership	84
3.1.4	Actual membership	85
<b>3.2</b>	<b>Financing the contest robot</b>	<b>85</b>
3.3	Sub-regional VHF/UHF/ $\mu$ Wave contest coordination within IARU-R1	85
<b>4</b>	<b>MGM CONTEST OPERATING PROCEDURES</b>	<b>86</b>
<b>4.1</b>	<b>Introduction</b>	<b>86</b>
<b>4.2</b>	<b>What needs to be logged?</b>	<b>86</b>
<b>4.3</b>	<b>Contest Exchange</b>	<b>86</b>
4.3.1	Standard Exchange	86
4.3.2	Responding to CQ (as sent in Tx6 above)	87
4.3.3	Notes:	87
<b>5</b>	<b>ELECTRONIC CONTEST LOG EXCHANGE</b>	<b>88</b>
5.1	Introduction	88
5.2	Logbook programs supporting EDI	88
<b>5.3</b>	<b>Standard format for Electronic Contest Log Exchange (Vienna 1998)</b>	<b>89</b>
5.3.1	Format	89
5.3.2	Explanation of keywords in header	90
5.3.3	QSO record definition	93
5.3.4	Characters	93
5.3.5	Line length	93
5.3.6	Separator (;)	94
5.3.7	Faulty QSOs	94
5.3.8	QSO numbers	94
5.3.9	Missing information	94
5.3.10	Example: Region 1 Contest, standard type	94
5.3.11	Example : AGCW DL VHF Contest (contest manager: DJ2QZ)	96
<b>5.4</b>	<b>AUTOMATIC CONTEST ADJUNCTION SOFTWARE</b>	<b>98</b>

**PART 4: OPERATIONAL & TECHNICAL REFERENCES**

<b>1</b>	<b>OPERATING PROCEDURES</b>	<b>100</b>
1.1	Minimum Requirement for a valid QSO	100
1.2	Weak-signal QSO procedure	101
1.2.1	The Basis of the Procedure	101
1.2.2	Procedure	101
1.2.3	Valid Contacts	101
1.3	Operating code of practice for 50 MHz operators	102
1.3.1	50 MHz as a DX band	102
1.3.2	Band plan	102
1.3.3	Local QSO's	102
1.3.4	Learn to listen	102
1.3.5	50.100 - 50.130 MHz window for intercontinental contacts	102
1.3.6	50.110 MHz Intercontinental calling frequency	102
1.3.7	50.110 MHz CQ'ing	102
1.3.8	QSO techniques	102
1.3.9	DX pile-up operating	102
1.3.10	Split frequency operation	102
1.3.11	Duplicate QSO's	102
1.3.12	Telegraphy operation	102
1.3.13	FM QSO's in Europe	102
1.3.14	Mutual interference	102
1.4	Operating procedures for Meteor Scatter QSO's	103
1.4.1	Introduction	103
1.4.2	Scheduled and Random Contacts	103
1.4.3	Timing	103
1.4.4	Transmit periods	103
1.4.5	QSO duration	104
1.4.6	Frequencies	104
1.4.7	QSY frequencies for MGM	104
1.4.8	QSO procedure	105
1.4.9	Valid contacts	106
1.4.10	Additional information for communication before and during the MS QSO	106
1.5	QSO Procedure for Airplane Reflections	107
1.5.1	Calling	107
1.5.2	Reporting system	107
1.5.3	Reporting procedure	107
1.5.4	Confirmation procedure	107
1.5.5	Requirements for a complete QSO	107
1.6	Rapid Deployment Amateur Radio (RaDAR)	108
1.6.1	Introduction	108
1.6.2	The concept	108
1.6.3	Modes of communication	108
1.6.4	Summary	108
1.7	Operating practice for digital modes	109

IARU-R1	
1.7.1	Guidelines for Packet Radio Operators 109
1.7.2	Guidelines for Packet Radio Bulletin Board Operators 109
1.7.3	Guidelines for APRS 109
<b>2</b>	<b>AMATEUR SATELLITES 110</b>
2.1	Introduction 110
2.2	IARU Region 1 and IARU Satellite Coordination 110
2.2.1	General 110
2.2.2	Satellites transmitting on Amateur bands with undocumented protocols or without permission 110
2.3	Amateur Satellite Names 111
2.4	Amateur-satellite operating practice 112
2.5	Amateur Satellite Band Plan Usage 113
2.6	Satellite Transponder Designations 114
2.7	Amateur Satellite Organisations 115
2.8	Current Satellites 115
<b>3</b>	<b>SIGNAL REPORTING SYSTEM 116</b>
3.1	Signal reporting ( Recommendation R.1; R.2) 116
3.1.1	IARU Region 1 Technical Recommendation S-METER READINGS 116
3.1.2	IARU Region 1 Technical Recommendation TONE REPORTS 117
3.2	The RSQ (Readability Strength Quality) reporting scale for digital modes: 118
3.2.1	Readability (% of text) 118
3.2.2	Strength 118
3.2.3	Quality 118
3.3	The MOS (Mean Opinion Score) reporting scale for digitized speech: 119
<b>4</b>	<b>THE LOCATOR SYSTEM 120</b>
4.1	Background 120
4.2	Updating the Definition of the IARU locator 120
4.3	Definition of the original IARU locator 120
4.4	Problems with the Existing Scheme 121
4.5	New Higher Resolutions 121
4.6	Mapping and Accuracy 122
4.7	Proposals to Clarify and Standardise the IARU Locator, including higher Accuracy positioning 122

<b>5</b>	<b>ANTENNA POLARISATION ( RECOMMENDATION P.1.)</b>	<b>123</b>
5.1	IARU-R1 1 Technical Recommendation (Signal Polarisation)	123
5.1.1	Standards for signal polarisation	123
<b>6</b>	<b>DEFINITION FOR PING AND BURST FOR SCIENTIFIC ANALYSIS OF AMATEUR RADIO METEOR SCATTER</b>	<b>124</b>
6.1	Definitions	124
6.2	Background:	124
6.3	Aid for defining underdense and overdense trails	125
6.3.1	Maximum duration of an underdense reflection (ping):	125
6.3.2	References:	125
<b>7</b>	<b>FREQUENCY MODULATED TELEPHONY</b>	<b>126</b>
7.1	The basic FM standard (Recommendation FM.1.)	126
7.1.1	IARU Region 1 Technical Recommendation FM.1	126
7.2	FM Repeaters ( Recommendation FM.2.)	127
7.2.1	IARU Region 1 Technical Recommendation FM.24	127
7.2.2	CTCSS frequencies Hz to be used for repeater access	128
7.2.3	DTMF frequency pairs	129
<b>8</b>	<b>DIGITAL TRANSMISSIONS</b>	<b>130</b>
<b>8.1</b>	<b>Principles for digital modes</b>	<b>130</b>
8.2	Packet-radio (mailbox) operating practice	130
8.3	Concerning the relaying of messages to amateur stations	131
8.4	Concerning guidelines for packet radio	132
8.5	IPv6 allocation	133
<b>8.6</b>	<b>Digital voice</b>	<b>134</b>
<b>9</b>	<b>AMATEUR ( WIDE BAND ) TELEVISION</b>	<b>135</b>
9.1	Vestigial Sideband AM ( Recommendation V.1.1.)	135
9.2	Medium bandwidth ATV ( Recommendation V.1.2.)	135
9.3	FM-ATV (Recommendation V.2. )	135
9.4	IARU Region 1 technical recommendations concerning ATV	136
9.4.1	IARU Region 1 Technical Recommendation BASIC FAST SCAN AMATEUR TV STANDARD	136
9.4.2	IARU REGION 1 TECHNICAL RECOMMENDATION SATV	136
9.4.3	IARU Region 1 Technical Recommendation V.3	136

IARU-R1	
9.4.4	IARU Region 1 Technical Recommendation V.2 for Microwave ATV 137
9.4.5	IARU Region 1 Technical Recommendation for Digital ATV 138
<b>10</b>	<b>BEACON REQUIREMENTS 139</b>
10.1	Beacon message 139
10.2	Operation 140
10.3	Beacons spectrum 141
10.4	Status 141
<b>11</b>	<b>PROPAGATION RESEARCH BY AMATEURS 142</b>
11.1	Introduction 142
11.2	Coordination of amateur participation in propagation research 143
11.2.1	Sporadic-E investigations 143
11.2.2	Auroral propagation 144
11.2.3	Tropospheric propagation studies 144
11.2.4	Information exchange programme 144
11.2.5	Co-operation with CCIR study groups and publications 144
11.2.6	Action/support required from IARU Region 1 member societies 145
11.2.7	Cooperation with the DUBUS magazine 145
11.2.8	Propagation database 145
<b>12</b>	<b>VHF/UHF/<math>\mu</math>WAVES RECORDS 146</b>

<b>PART 5: HISTORICAL DATA</b>
--------------------------------

<b>1 LIST OF CHANGES</b>	<b>148</b>
<b>2 IARU INFORMATION</b>	<b>150</b>
2.1 IARU Region 1 VHF/UHF/ $\mu$ Waves Committee	150
2.1.1 Constitution and terms of reference of the IARU-R1 VHF/UHF/ $\mu$ Waves Committee	150
2.1.2 Constitution and Bye-Laws of the IARU Region 1	150
2.1.3 Constitution and Bye-Laws of the IARU	150
2.2 IARU Region 1 Conferences	151
2.3 IARU Region 1 VHF/UHF/Microwaves Committee Chairs	151
2.4 Notes on tasks IARU-R1 and its VHF/UHF/ $\mu$ Waves committee	152
2.4.1 Resolution 91-1 (concerning the improper use of the amateur bands)	153
<b>2.5 Deleted functions</b>	<b>154</b>
2.5.1 Frequency allocations coordinator	154
2.5.2 Database keeper	155
<b>3 BEACONS</b>	<b>156</b>
3.1 IARU R-1 VHF and $\mu$ Wave beacon list (deleted in Landshut 17)	156
<b>4 BANDPLANNING</b>	<b>157</b>
4.1 Historical data	157
4.2 Deleted during the Landshut conference (2017)	158
4.2.1 50 MHz	158
4.2.2 144 MHz	158
4.2.3 432 MHz	159
<b>5 CONTESTING</b>	<b>160</b>
5.1 History	160
5.2 Organisation	160
5.3 Procedure	161
5.3.1 Information	161
5.3.2 Organisation	161
5.3.3 Timing	161
5.3.4 Flow chart contest evaluation	162
5.4 Rules	163
5.4.1 All-band sub-regional contests	163
5.4.2 Microwave contest	163

IARU-R1	
5.4.3	Experiment with scoring system: Locator bonuses 164
5.4.4	Introduction of locator bonus in contests 164
5.4.5	Information exchange on contests 164
<b>5.5</b>	<b>VHF/UHF/<math>\mu</math>Wave Challenge trophies and medals: history and winners 165</b>
<b>5.6</b>	<b>Rules until 2017 167</b>
5.6.1	Definitions 167
5.6.1.1	Station: 167
5.6.1.2	Location: 167
5.6.1.3	Call Sign: 167
5.6.1.4	• Operator: 167
5.6.1.5	Multi operator: 167
5.6.1.6	Single operator: 167
5.6.2	Eligible entrants 167
5.6.3	Contest sections 167
5.6.4	6 HOURS section time rule: 168
5.6.5	Operating 168
5.6.6	Date of contests 168
5.6.7	Duration of contests 168
5.6.8	Contacts 168
5.6.9	Type of emission 169
5.6.10	Contest exchanges 169
5.6.11	Scoring 169
5.6.12	Entries 169
5.6.13	Judging of entries 170
5.6.14	Use of secondary means 170
5.6.15	Awards 170
5.6.16	Logs 171
<b>5.7</b>	<b>List of member societies charged with organising the IARU-R1 contests 172</b>
<b>6</b>	<b>LOCATOR SYSTEM 174</b>
<b>6.1</b>	<b>History 174</b>
<b>6.2</b>	<b>Description of the Locator system 175</b>
<b>6.3</b>	<b>Basis for determination of locators 175</b>
<b>6.4</b>	<b>Extended locator system 177</b>
<b>7</b>	<b>DIGITAL COMMUNICATION 178</b>
<b>7.1</b>	<b>Data-transmission ( Recommendations D.1.1. and D.1.2.) - removed 178</b>
7.1.1	IARU Region 1 Technical Recommendation D.1.1 178
7.1.2	IARU Region 1 Technical Recommendation D.1.2 178
<b>7.2</b>	<b>Digital telephony ( Recommendation D.2.) (removed DAVOS 2005) 179</b>





# PART 1

## IARU-R1 VHF & UP ORGANISATION

## **1 ORGANISATION**

### **1.1 Constitution of the IARU Region 1 VHF/UHF/Microwaves Committee**

The following articles in the IARU Region 1 Constitution and Bye-laws relate to the permanent IARU Region 1 VHF/UHF/Microwaves Committee

#### **1.1.1 In the Constitution:**

A.1.4.7 Definition of specialised bodies

A.5 Nomination, period of office etc. of specialised bodies

N.B. Article A4.11 allows the IARU Region 1 Executive Committee to invite the Chairmen of the permanent HF and VHF/UHF/Microwaves Committees to their meetings - as has been the custom since 1975.

#### **1.1.2 In the Bye-laws:**

B.1.14 Steering Committee at Conferences: membership Chairmen Permanent Committees B.1.18

Function of Permanent VHF/UHF/Microwaves Committee

B.3.10-29 Procedures for set-up and work of Permanent Specialised Bodies

N.B. Section B.1. of the Bye-laws deals with the procedures for organising a General Conference. Especially the articles dealing with the submission of papers containing proposals and of papers only containing information merit attention!

Delegates to the IARU Region 1 VHF/UHF/Microwaves Committee should be national VHF Managers and/or members of their national VHF Committee or equivalent body.

For the office of Chairman of the IARU Region 1 VHF/UHF/Microwaves Committee an amateur who is not a national VHF Manager nor a member of a national VHF Committee or equivalent body is eligible, provided he has previously been a member of the IARU Region 1 VHF/UHF/Microwaves Committee, but only for a period of six years from the time he is no longer the VHF Manager or member of the VHF Committee or equivalent body of his society<sup>1</sup>.

At the IARU Region 1 Conference in Noordwijkerhout (1987) the following recommendation was adopted: In view of the heavy work pressure and many items to be discussed the IARU Region 1 VHF/UHF/Microwaves Committee should have annual meetings (i.e. two meetings between successive IARU Region 1 General Conferences) (1).

A list of members of the IARU Region 1 VHF/UHF/Microwaves Committee is given in section Ig.

---

<sup>1</sup> Wording brought in accordance with the IARU Region 1 Constitution adopted at the IARU Region 1 Conference in Noordwijkerhout (1987).

### **1.1.3 Terms of reference of the IARU Region 1 VHF/UHF/Microwaves Committee**

The tasks of the IARU Region 1 VHF/UHF/Microwaves Committee are:

To co-ordinate the activities of amateurs in IARU Region 1 with respect to frequency allocations above 30 MHz.

To ensure that adequate use is made of existing allocations and to consider possible new allocations.

To co-ordinate and promote scientific investigations by member societies of IARU Region 1 on all frequencies above 30 MHz.

To recommend IARU Region 1 individual bandplans aimed at promoting greater effectiveness both for local and long distance communications.

To encourage special projects on the frequency allocations above 30 MHz aimed at advancing amateur radio communication techniques, e.g. amateur satellite projects.

To assist in the protection of the amateur allocations above 30 MHz from possible loss by stimulating activity and demonstrating the effective use by amateurs (see note below).

To plan and conduct IARU Region 1 VHF/UHF/Microwaves contests and to coordinate sub-regional contests on these bands.

To advise on interference problems especially relating to the VHF/UHF/Microwaves bands.

Exchange of information will be provided by:-

- complimentary exchange of society journals between VHF Managers, already decided upon at the IARU Region 1 Conference in Lausanne (1953);
- the Region 1 News bulletin produced by the Secretary of IARU Region 1;
- a Newsletter by the Chairman of the IARU Region 1 VHF/UHF/Microwaves Committee for urgent items.

## **1.2 Tasks of IARU R-1 and its VHF/UHF/ $\mu$ Wave Committee**

The IARU and their regional organisations are the officially accredited representative of the Amateur Service and the Amateur Satellite Service at the International Telecommunications Union (ITU) and all their organisations and Conferences, like, for instance, the WARC's.

Apart from the contributions IARU Region 1 and its officers make to the above work, IARU Region 1 specifically represents the amateur interests at, amongst others, the Conference of European Post and Telecommunications Administrations (CEPT) and their European Radiocommunications Office (ERO) in Copenhagen, as well as at the European Union (EU) in Brussels.

The coordination of the representative work done by the IARU Region 1 is in the hands of the member of the IARU Region 1 Executive Committee, Don Beattie G3BJ

The most important tasks of the IARU and their regional organisations are:  
to defend, extend and upgrade the status of the frequency segments allocated by the ITU to the Amateur Service and the Amateur Satellite Service;  
to coordinate the orderly use of the frequency bands allocated to the Amateur service and the Amateur Satellite Service by the ITU and the national Administrations by careful bandplanning.

The supporting role of the IARU Region 1 VHF/UHF/Microwaves Committee with respect to the above tasks is clearly set out in the Terms of Reference of this Committee, given in PART 1 section 1.7 and 1.8 .

The defence, extension and management of the allocations above 30 MHz has been the subject of the following recommendations adopted by the IARU Region 1 on the basis of proposals brought forward by the IARU Region 1 VHF/UHF/Microwaves Committee. At the IARU Region 1 Conference in Scheveningen (1972) the following recommendation was adopted:-

Member societies are strongly recommended to establish and maintain contact with their national Administrations at a policy level to ensure that the case for amateur radio in the VHF/UHF/Microwaves bands is properly known and can effectively be presented by each Administration at future frequency allocation Conferences. VHF Managers are to see that the Councils of their societies pursue this policy and will ensure that the Secretary of IARU Region 1 is kept informed of developments with national Administrations.

### **1.3 Microwave managers Sub-committee**

At the IARU Region I Conference in Warsaw (1975) the following recommendation was adopted : VHF managers will stimulate national interest in the 1 - 30 GHz microwave bands. In addition, DARC will direct special attention to the 2.3 GHz band and RSGB to the 10 GHz band by publishing information on the design of suitable equipment and on results achieved on these bands.

At the meeting of the VHF Working Group in Amsterdam (October 1976) it was agreed that all societies should nominate a person to act as focal point for the reception and distribution of microwave information and material. The names of the persons to act in this way should be sent to the Secretary of IARU Region I. Furthermore, any changes in focal points should immediately be advised to the Secretary of Region I. All focal points would investigate the possibility of starting microwave columns in the journal of their national society.

Since the above recommendations were adopted, in several societies these focal points have developed into full-fledged Microwave Managers running their own microwave column in their society's journal.

During sessions of the IARU Region 1 VHF/UHF/Microwaves Committee at Region 1 Conferences as well as meetings of the VHF/UHF/Microwaves Committee in the years between Conferences a sub-committee of Microwave Managers pre-advises ( when requested by the meeting ) on matters concerning microwave frequencies. For this purpose the frequency of 1 GHz has been adopted as the lower microwave boundary (Brighton, 1981).

A list of Microwave Managers can be found in PART 1 section 1.8

## 1.4 Coordinators of the VHF/UHF/Microwaves Committee

### 1.4.1 VHF Contest Coordinator

It is proposed to create a team of experienced VHF contesters and contest robot owners/designers to define common checking rules for automatic contest adjudication applications coordinated by the Contest coordinator (Landshut 2017) see also PART 3

### 1.4.2 Satellite coordinator

Amateur Satellite activities are predominantly taking place in the VHF, UHF and Microwave bands. The Region 1 VHF/UHF/Microwave Committee therefore, has to take the Amateur Satellite Service into account in all aspects of its work.

In Region 1 (and in other Regions as well) specialist groups in many countries deal with amateur satellite matters and the communication between the (representative of) the member societies and those groups is not always optimum.

Within the IARU there exists a Satellite Advisor function but his tasks are mostly oriented towards worldwide coordination. The VHF/UHF/Microwaves Committee, therefore, decided at its meeting in Lillehammer 1999 to create the function of Region 1 VHF/UHF/Microwaves Satellite Coordinator.

The tasks of the coordinator are:

To liaise

1. with all groups which specialise in amateur satellite matters in Region 1 countries,
2. with the IARU Satellite Advisor and
3. with all other relevant people/organizations.

To inform the committee about all satellite matters relevant to its work by:-

4. Maintaining the Amateur Satellite section of the VHF Managers Handbook,
5. Contributing to the VHF Newsletter
6. Contributing to meetings of the committee.

The coordinator, therefore, should preferably

be an active and recognized operator in the amateur satellite service

have a good knowledge of English ( speaking and writing)

have the support of the IARU member society in his country ( preferably being a member of his societies delegation to meetings of the committee)

### 1.4.3 Beacon coordinator

See point 5

### 1.4.4 Propagations coordinators

Ionospheric Propagation Coordinator - t.b.f.

Auroral Propagation Coordinator - t.b.f.

Tropospheric Propagation coordinator - t.b.f.

### 1.4.5 Records coordinator

The VUSHF DX Records Homepage has been moved to <http://dxrecords.vushf.dk> (Varna 2014)

### 1.4.6 Repeater coordinator

His task is to keep the information up to date about IARU-R1 repeaters on the IARU website. National societies should provide their information to him. (Varna 2014)

## 1.5 IARU R-1 Executive Committee

For actual contact information please visit: <http://www.iaru-r1.org> (About IARU Region 1 -> Executive Committee)

IARU-R1

## 1.6 Actual IARU-R1 VHF/UHF/SHF Chairman, Co-ordinators and co-workers

<b>Chairman</b> Passchijnstraat 22A B8400 Oostende BELGIUM	Verleijen Jacques ON4AVJ mobile: +32 473 860 111 ON4AVJ@uba.be	tel : +32 9 224 09 55
<b>Vice Chairman</b>	Jann Traschewski DG8NGN Germany	jann@gmx.de
<b>VHF/UHF/Microwave Contest Coordinator</b>	Alessandro Carletti, IV3KKW Italy	iv3kkw@gmail.com
<b>VHF/UHF/Microwave Beacons Coordinator</b>	Matthias Klug DH4FAJ Germany	dh4faj@darc.de
<b>Region 1 Satellite Coordinator</b>	Graham Shirville, G3VZV England	g3vzv@amsat.org
<b>Spectrum expert</b>	Murray Niman, G6JYB England	g6jyb@microwavers.org
<b>VHF/UHF/Microwave Records Keeper</b>	Kjeld Bülow Thomsen OZ1FF Denmark	kjeld@oz1ff.dk
<b>Repeater information Coordinator</b>	Mats Espling SM6EAN Sweden	sm6ean@ssa.se

**1.7 National VHF managers**

<b>AFVL</b>	Alois W. Buchel, HB0MUO LIECHTENSTEIN	
<b>ARAI</b>	Jean Jacques Niava, TU2OP Côte d'Ivoire	<a href="mailto:jjniava@comete.ci">jjniava@comete.ci</a>
<b>ARABi</b>	Medzid Dautovic-Kico, T95C	
<b>ARI</b>	Alessandro Carletti, IV3KKW Via Colvera, 26 33085 Maniago PN ITALIA	<a href="mailto:iv3kkw@gmail.com">iv3kkw@gmail.com</a>
<b>BFRA</b>	Assen Kanef – LZ2HQ BULGARIA	<a href="mailto:lz2hq@abv.bg">lz2hq@abv.bg</a>
<b>CARS</b>	Christis Christodoulou, 5B4SN CYPRUS	<a href="mailto:christis91@gmail.com">christis91@gmail.com</a>
<b>CRC</b>	Petr Kasperek, OK2ULQ CZECH REPUBLIC	<a href="mailto:ok2ulq@seznam.cz">ok2ulq@seznam.cz</a> Mobile +420 602 533 338
<b>DARC</b>	Jann Traszewski DG8NGN GERMANY	Tel: +49 911 99946898 <a href="mailto:dg8ngn@darc.de">dg8ngn@darc.de</a>
<b>ERASD</b>	Sayed Abdel Samie SU1SA Egypt	<a href="mailto:kh_sayed@yahoo.com">kh_sayed@yahoo.com</a> .
<b>EDR</b>	Ivan Stauning, OZ7IS DENMARK	tel : +45 43 523314 <a href="mailto:oz7is@edr.dk">oz7is@edr.dk</a>
<b>ERAU</b>	Mart Tagasaar, ES2NJ Estonia	mobile: +372 51 07808 <a href="mailto:es2nj@erau.ee">es2nj@erau.ee</a>
<b>FRR</b>	Burducea Ovidiu Vasile YO9XC Romania	<a href="mailto:frr@hamradio.ro">frr@hamradio.ro</a> , <a href="mailto:yo9xc@yahoo.com">yo9xc@yahoo.com</a>
<b>HRS</b>	Petar Milicic, 9A6A Republic of Croatia	<a href="mailto:9a6a@hamradio.hr">9a6a@hamradio.hr</a> GSM: 00385912006432
<b>IARC</b>	Dan Katzman, 4Z5SL ISRAEL	<a href="mailto:dkatzman@shamir.co.il">dkatzman@shamir.co.il</a>
<b>IRTS</b>	Stephen C. Wright EI5DD	<a href="mailto:wrights14@gmail.com">wrights14@gmail.com</a>
<b>LRAL</b>	Vitautis Klimavicus, YL3AG LATVIA	fax +371 2971721 e-mail: <a href="mailto:lrал@acad.latnet.lv">lrал@acad.latnet.lv</a>



## IARU-R1

<b>LRMD</b>	Andy Sharpilo LY2HQ Lithuania	ly2hq@lrmd.lt
<b>MARL</b>	Philip Aquilina, 9H1PA MALTA	tel: +356 21433218 or +356 79433218 phillipa@maltanet.net
<b>MRASZ</b>	Joe Devenyi, HA0LC Hungary	joe@anico.hu tel (QRL): +36 42 507 – 620
<b>NRRL</b>	Hans Utne Norway	e-mail : vhfmanager@nrri.no
<b>ÖVSV</b>	Thomas Ostermann, OE7OST AUSTRIA	e-mail: oe7ost@oevsv.at
<b>PZK</b>	Tomasz Babut, SP5XMU Poland	e-mail: sp5xmu@wp.pl
<b>RAAG</b>	Costas.Fimerelis, SV1DH	e-mail: sv1dh@otenet.gr
<b>REF</b>	Philippe Martin, F6ETI FRANCE	Tél: 0033 5 55 84 76 88 e-mail: f6eti@wanadoo.fr
<b>REP</b>	<b>CT1END Carlos Nora</b> <b>PORTUGAL</b>	ct1end@gmail.com
<b>RL</b>	Jeng Jungels LUXEMBURG	mail : iaruvhf@rlx.lu
<b>RSGB</b>	John Regnault G4SWX United Kingdom	john.regnault@btinternet.com
<b>ROARS</b>	Nasser al Rwawahi Sultanate of Oman	tel +968 600407 fax: +968 698558 e-mail : roars@omantel.net.om
<b>RSM</b>	Todorovski Todor , Z31RM Macedonia	phone:+389 47 242585 Z31RM@mt.net.mk
<b>SARA</b>	Rasto Hrnko, OM3BH SLOVAKIA	om3bh@centrum.sk
<b>SARL</b>	Riaan Greeff, ZS4PR Rep. of South Africa	vubandplanning@sarl.org.za
<b>SRAL</b>	Jussi Liukkonen, OH5LK FINLAND	tel : +358 53543242 e-mail:oh5lk@sral.fi
<b>SRJ</b>	Miki Markovic, YU1AU SERBIA	tel +381 12 221 390

IARU-R1

<b>SSA</b>	Mats Espling, SM6EAN SWEDEN	Tel: +46 31 29 42 74 e-mail: sm6ean@ssa.se
<b>SRR</b>	Dmitry Dmitriev, RA3AQ Moscow, Russia	Phone: +7(905)742-7890 e-mail: ra3aq@vhfdx.ru
<b>TRAC</b>	Kadri Mehmet BASAK , TA1D Turkey	kadrimehmet@gmail.com
<b>UARL</b>	Yuri Gorets, UT5EL UKRAINE	ut5el(at)mail.ru
<b>UBA</b>	Stefan Dombrowski ON6TI Belgium	ON6TI@uba.be
<b>URA</b>	Xavier Perez,C31PM Principat d'Andorra	e-mail : ura@andorra.ad
<b>URE</b>	Anibal Garcia, EA1ASC Spain	ea1asc@ure.es vhf@ure.es
<b>USKA</b>	Hans-Peter Strub, HB9DRS Switzerland	e-mail: vhf@uska.ch
<b>VERON</b>	Dick van der Knaap, PA4VHF The Netherlands	e-mail : voorzitter.vhf-en-hoger@veron.nl
<b>ZRS</b>	Miha Habic, S51FB Slovenia	s51fb@slovhf.net

**1.8 MICROWAVE MANAGERS**

<b>CRK</b>	František Stihavka, OK1CA Czech Republic	tel. : +42 2 81910081
<b>EDR</b>	Kjeld Bülow Thomsen, OZ1FF DENMARK	tel. +45 73 52 60 50 mobile: +45 40 21 11 19 kjeld@oz1ff.dk
<b>ÖVSV</b>	Wolfgang Hoeth, OE3WOG Austria	tel : +43 650 6505300 e-mail: oe3wog@oevsv.at
<b>REF</b>	Sylvain AZARIAN F4GKR France	
<b>RSGB</b>	Barry Lewis, G4SJH United Kingdom	e-mail: barryplewis@btinternet.com
<b>SRAL</b>	Jari Koivurinne OH3UW FINLAND	e-mail: oh3uw@sral.fi
<b>SSA</b>	Jens Tunare, SM6AFV SWEDEN	jens.tunare@gmail.se Tel: +46 70 590 5007
<b>UBA</b>	Peter Pauwels, ON7BPS Belgium	tel : +32 3 6517451 on7bps@telenet.be

**1.8.1 Note.**

If a member society has not nominated a Microwave Manager, the VHF Manager may be assumed to be also responsible for microwave matters.

## 2 RECOMMENDATIONS FOR VHF MANAGERS

### 2.1 Protect our amateur bands(Landshut 2017)

#### 2.1.1 General

All IARU bodies and member societies use every opportunity to exert pressure on national regulators to implement all the recommendations that protect the amateur bands.

#### 2.1.2 24 and 47 GHz band

In order to protect the 24 and 47 GHz band it is recommended that:

- IARU member societies fully engage with their national administrations to ensure they are fully aware of the radio amateur interest in their countries in the 24 GHz and 47 GHz bands.
- IARU member societies ensure their national administrations actively support the protection of the amateur radio services in the 24 GHz and 47 GHz bands in the WRC-19 preparatory studies.
- IARU member societies encourage their national interest groups to publicise and highlight their achievements in these frequency bands (including by web pages, social media, YouTube, etc.)

#### 2.1.3 Millimetre bands

In order to protect and develop the use of the millimetre wave bands it is recommended that Member Societies should;

- recognise the importance of the millimetre wave frequency bands as territory for experimentation and innovation.
- recognise that the ability to exploit these frequencies reflects the true amateur radio spirit of self-learning and training.
- encourage national interest-group organisations to provide a forum for efficient sharing of experiences and ideas amongst their amateur communities for the use of these bands.
- facilitate the organisation of events and meetings (including contests) that can allow like-minded enthusiasts to exchange ideas.
- take steps to highlight and promote activity and experimentation in this area with their national and regional administrations.

#### 2.1.4 50 MHz Band

That work start immediately to review the 50 MHz band plan, in the light of emerging new requirements (including digital wideband applications), with the intention to present proposals for a new bandplan to the General Conference in 2020, including the impact of any outcome from WRC19.

## 2.2 Defending the bands from 1 GHz to 10 GHz (Vienna 2019)

### 2.2.1 Introduction

The growth in consumer and commercial wireless applications is putting increasing pressure on all the microwave amateur service bands above 1GHz. Many of the amateur service allocations have a secondary status in the international regulatory framework which leaves them particularly vulnerable in the face of concerted commercial and political pressure.

For amateurs, the lower microwave bands provide a springboard for developing interest and skills in the use of higher bands. Modern components, sub-systems, surplus equipment and software radio technology have improved their accessibility for experimentation and operation of high-performance amateur systems.

### 2.2.2 Actions

Member Societies are encouraged to raise the profile of microwave and millimetre wave band operation in the context of experimentation and innovation in amateur radio activity.

The following recommendations are proposed for ALL Member Societies:

- **Appoint a specific microwave manager** to help raise the profile of the interest in these bands. (The latest VHF Handbook currently lists just 8).
- **Engage closely with the activities of national administrations** (e.g replying to consultations and attending workshops) relating to national spectrum management of the bands above 1GHz.
- Member Societies should drive a position with their administration that unrestricted amateur services can successfully **share spectrum with commercial users** as demonstrated already in some bands.
- Engage closely with national administrations to ensure that **amateur stakeholder interests feed into international spectrum management** developments.
- Ensure that national administrations are aware of the **interest and opportunity** these bands provide for **experimentation, training and learning**.
- **Provide incentives** to individuals and clubs to encourage construction and operation in these bands (e.g. awards, publicity).
- Ensure national administrations understand the importance that the range of amateur allocated frequency bands provides in enabling differing opportunities and challenges for amateur activities.
- Be ready to question any unreasonable national restrictions on amateur usage that appear disproportionate or unrealistic.

## 2.3 Licenced share access (LSA)

IARU Region 1 needs to create guidance and prerequisites on how Licence Share Access (LSA) may work in an Amateur Radio context. This can support member societies to prepare for future national discussions where LSA is proposed to be the future way for am-ateur radio to retain access to spectrum.

## 2.4 Band activity survey

It is recommended that a task group is formed within the C5 Committee to compile a survey of actual band usage and activity above 148 MHz, as requested by the IARU AC, to ensure it is completed by all the Member Societies and send the conclusions to IARU AC by the be-ginning of 2018 to update the IARU database of band usage for use in ITU discussions.

## 2.5 Proper use of amateur frequencies (Cavtat 2008)

Member Societies are recommended to promote the proper use of amateur frequencies consistent with the international Radio Regulations, with a view toward maintaining the integrity of the amateur service and its frequency allocations as well as promoting the success of amateur satellite activities in their country.

## **2.6 Satellite frequency coordination (Cavtat 2008)**

Member Societies are recommended to work closely with the IARU Satellite Adviser and his Advisory Panel, and with their national administrations, with respect to requests for satellite frequency coordination originating in their respective countries.

## **2.7 145MHz for satellite downlinks (Cavtat 2008)**

The presence of interfering non-amateur signals in the 145.80-146.00MHz part of this band, in many parts of the world, is well documented. To prevent the retransmission of interfering terrestrial signals, satellites in the Amateur Satellite Service that plan to use the 145MHz Amateur band for transponders, are encouraged to use this band for downlink (satellite to ground) modes only, regardless of modulation type.

## **2.8 Multi-Band beacon clusters (Cavtat 2008)**

National Societies should encourage the deployment of multi-band beacon clusters covering low VHF between about 30 MHz and about 70 MHz.

Deployed beacon clusters should wherever possible provide signals at around 40 MHz and around 60 MHz.

Amateurs should be encouraged to set up and maintain automated monitoring stations and to contribute the measurement results to the community.

A common transmission format should be adopted to aid the reception of multiple clusters

## **2.9 3400-3410MHz allocation**

National Societies should take all necessary steps in seeking 3400-3410MHz allocations on a Secondary non-interference basis as quickly as possible.

All Societies should explicitly include the Amateur Satellite Service (both SAT-Earth and Earth-SAT) in such requests on the basis that many years of terrestrial and EME operations (notably in the CEPT area) have not resulted in interference reports from other users.

National Societies and IARU-R1 should collaborate more closely to assist those Societies who in the past have not been able to achieve such allocations.

Societies should collectively obtain a critical mass of national allocations so that footnotes in regional allocation tables can be extended or acquired that include the Amateur Satellite Service

IARU-R1 to prioritise this band and to take active steps in support of these goals

## **2.10 Contest Log exchange**

National VHF Managers or properly nominated Contest Committees should send the electronic contest log data entries from IARU R1 contests to a special web page to allow an exchange of logs for more accurate national evaluation.

## **2.11 DX code of conduct (Varna 2014)**

It is recommended that member societies endorse and promote the "DX Code of Conduct for DXpeditions" published on <http://www.dx-code.org/>

## **2.12 TV Repeater Transmissions (Varna 2014)**

In any band where there is serious compatibility issue, TV Repeater Outputs must minimise their overall transmissions to reduce the potential for interference.

In such bands, continuous beacon or testcard transmissions are a particular problem and should be phased out in favour of short regular transmissions or transmit-on-demand.

### **2.13 Remote Controlled Operation (Varna 2014)**

Remote controlled operation is defined to mean operation where a licensed operator controls an amateur radio station from a remote control terminal.

Where a station is operated remotely, the following conditions shall apply:

Remote operation must be permitted, or not objected to, by the Regulatory Authority of the country where the station is located.

The call sign to be used should be the call sign issued by the Regulatory Authority of the country in which the station is located. This applies irrespective of the location of the operator.

It should be noted that Recommendation SC11\_C4\_07 states that member societies bring to their members attention that the T/R 61-01 agreement only applies to people using their own call sign, with the appropriate country prefix, when the operator is actually visiting that country, not for remote operation.

Any further requirements regarding the participation of remotely controlled stations in contests or award programmes are a matter for the various contest or award programme organisers.

Note: CEPT T/R 61-01 can be found at <http://www.erodocdb.dk/docs/doc98/official/pdf/TR6101.pdf>

### **2.14 Information about repeaters**

It is recommended that all repeater information should be found on the IARU R1 website, or by a link from the IARU R1 website. Member societies should send their information to SM6EAN (Varna 2014)

## 3 IARU R-1 AND IARU SATELLITE COORDINATION

### 3.1 ITU Notification Requirements for Amateur Satellites

#### 3.1.1 Background

In recent years there has been a dramatic increase in the number of satellites being launched which operate on frequencies in the Amateur Satellite Service.

The Amateur Satellite Service has different and less onerous notification and registration requirements than most other Satellite services. However it has been noted that many satellites have not actually been notified to the ITU at all. This has led to their records of frequency usage, which are often examined by other services, providing an incomplete picture to our possible detriment. This section shows the correct procedure which should be followed for all such projects.

It should be noted that this ITU procedure should proceed in parallel with the IARU Frequency Coordination process which is still required. All member societies are requested to familiarise themselves with this procedure and to encourage/ensure that satellite builders in their country follow the process.

#### 3.1.2 Procedure

##### *The Potential Amateur Satellite Builder*

- A potential amateur satellite builder is required to inform their National Telecommunications Regulatory Authority about their planned satellite project.

##### *The Regulatory Authority*

- Verifies that the project is in accordance of Article-25 and other provision of the Radio Regulations (RR)
- Checks if the satellite, telemetry and command ground station(s) will be operating under valid amateur licenses
- In cooperation with the responsible amateur licence holder, submits the required API (Advanced Publication Information) information to the ITU (Bureau) – see the required data in the wizard at:
- <http://www.itu.int/ITU-R/space/support/ARS/ARS-APIhelp.pdf>
- It is only necessary to send general orbital characteristics, frequency bands (not exact frequencies), emissions, service area, antenna diagrams and some other data – see the wizard.
- The Bureau will publish, based on the API data from the Regulatory Authority, an API/A special section to inform all administrations about the project
- At the same time (as submitting the API to the Bureau), or preferably earlier, the responsible amateur license holder should contact the IARU Satellite Adviser and submit all required information for the IARU amateur satellite frequency coordination process. See the information at <http://www.iaru.org/satellite/>
- The National Regulatory Authority (with help of the Bureau) has to solve any API potential problems (for example exclusion of country from the service area of the satellite) and the Bureau will publish it in API/B publication.
- When the IARU amateur satellite frequency coordination is completed the IARU Satellite Frequency Coordinator informs the responsible amateur license holder of the coordinated frequencies and some other (if necessary) conditions/restrictions.
- If all is in order, the National Regulatory Authority, in cooperation with the Satellite builder, submits the required notification data to the Bureau using SpaceCap software (see CR/303 for details) – more detailed data, including EXACT frequency assignments (notification wizard is under preparation)
- The Satellite has to be operational within 7 years from the date of the receipt of the API information. Notification shall reach the Bureau not earlier than 3 years before the satellite is operational. The Bureau will publish, based on the notification data, a PART I-S publication – acknowledgment



#### IARU-R1

- The Bureau will publish the result, in its technical and regulatory examinations and findings, in PART II-S publication – resulting in INTERNATIONAL RECOGNITION and RECORDING of the satellite in the Space Master Register following all regulatory requirements of the Radio Regulations

### **3.2 IARU-AC 89-3 concerning amateur satellite usage**

The IARU Administrative Council, Orlando, September 1989, recognised the important contributions made by amateur societies in the following areas:

- demonstration to the professional community that radio amateurs contribute to the development of state-of-the-art technology and techniques
- provision of new and challenging operational opportunities and training ground for radio amateurs to acquire new skills
- providing opportunities for training in an exciting technological field by direct participation, in schools, universities and professional organisations, and
- stimulating the interest of young people in a worthwhile activity, and encouraging the pursuit of a technological career to provide the next generation of industrial and research engineers.

Wishing to stimulate the growth of the Amateur Satellite Service in an orderly manner, the Administrative Council strongly supports the following goals:

- the encouragement of a wide dynamic range of activities stimulating training through increasing intellectual challenge
- the stimulation of young people in schools and universities to develop an interest in amateur radio through participation in amateur satellite activities
- where allowed, the provision of emergency services, especially to parts of the world that are less technologically developed, and
- the adoption of a "code of practice" that ensures the use of amateur frequency allocations by satellites in accordance with the spirit and ethos of amateur radio.

The Administrative Council resolved that:

- Member societies shall make Administrations more aware of the value and achievements of the Amateur Satellite Service.
- Satellites operating within amateur frequency allocations shall carry payloads and experiments that are relevant to, of interest to and available for participation by radio-amateurs worldwide.
- Operational frequencies of amateur satellites shall be in accordance with all applicable IARU band plans
- The use of higher frequency bands by amateur satellites shall be encouraged

### **3.3 Terms of reference of the IARU satellite adviser**

#### **3.3.1 General:**

An advisory and representational role, requiring technical knowledge and good interpersonal skills.

#### **3.3.2 Function**

To keep the Administrative Council informed on all technical and operational aspects of the amateur-satellite service, and to provide advice and assistance to enable the Council to adopt appropriate policies, and also to better inform the satellite community of the IARU.

#### **3.3.3 Appointment:**

The IARU Satellite Adviser shall be appointed by the Administrative Council and the position, the appointment and these terms of reference shall continue until the next meeting of the Administrative Council, which may or may not reconfirm this position, the appointment and these terms of reference.

#### **3.3.4 Tasks:**

- Report to the Administrative Council, providing information as to all developments in the satellite area, including all planned amateur satellites.
- At the request of the Administrative Council, provide technical and operational advice to assist the representation of the amateur-satellite service to the ITU.
- And attend such meetings of the satellite community as are appropriate.
- Represent generally the IARU to the satellite community and particularly to new or non-AMSAT satellite groups.
- To consult with and liaise with the satellite community as appropriate.
- To appoint any assistants that may be required.

### 3.4 Terms of reference of the IARU AMSAT satellite frequency coordinator

#### 3.4.1 General

The IARU AMSAT (Amateur Satellite) Frequency Coordinator (IAFC) is an operational role, requiring high technical competence and a detailed knowledge of amateur satellites, frequency management as well as of IARU band plans.

#### 3.4.2 Function

The IAFC shall assist the IARU Satellite Adviser and provide a service to enable any group to coordinate frequencies and emissions of a planned satellite intended to operate on Amateur Frequencies, under the license from the group's national administration, with existing and other planned amateur satellites.

#### 3.4.3 Appointment

The IAFC is appointed jointly by the IARU Satellite Adviser (ISA) in consultation with the consensus the recognized AMSAT Groups. The necessary liaison for this purpose with and among AMSAT Groups is to be conducted at the Annual IARU International Satellite Forum and, between Forum meetings, via Internet ([amsat-international@amsat.org](mailto:amsat-international@amsat.org)). The IAFC shall report both to the ISA and to the AMSAT Groups. The appointment is to last until the next Annual IARU International Satellite Forum, at which it may be reconfirmed or a new appointment made. The ISA after obtaining the concurrence of the AMSAT Groups as above, may revoke the appointment at any time, and the appointment shall thereupon cease. Any vacancy in this position, whether by resignation or revocation, shall be filled as soon as possible in the manner set forth above.

#### 3.4.4 Tasks

- Maintain a data base of all operating and planned satellites on Amateur Frequencies including frequencies, emissions and orbits.
- Upon request of an individual or group proposing to build a satellite to operate on Amateur Frequencies, provide information and advice to assist that prospective builder in the choice of frequencies and modes with the view of minimizing interference.
- Through publicity and direct communication, seek out prospective satellite builders and to encourage them to make use of this service. This function is jointly shared with the ISA.
- Promptly provide all information required by the ISA.
- After taking into account the input from various experts, it is the IAFC's task to make appropriate recommendations to the satellite builder(s). The IAFC is supported in this task by the ISA.
- Publish quarterly reports for distribution to the ISA, IARU national Societies and AMSAT Groups. Distribution to the AMSAT Groups will be considered fulfilled if said reports are posted on the [amsat-international@amsat.org](mailto:amsat-international@amsat.org) Internet distribution.
- While this position is a technical position, the IAFC has an important role in assisting in the protection of bands allocated to the amateur satellite service.
- To this end the IAFC is tasked to work with the AMSAT Groups to develop a protection plan which should be submitted to the IARU Satellite Adviser who's task it is to achieve endorsement from the IARU Regions and incorporation in band plans.

It is also important that the role of the IAFC is not confused with that of the ISA. To this end:-

- The role of the IAFC is restricted to providing advice as set out above, and in particular shall not make any statement(s) that could be understood to be expressing IARU policy, which will be the role of the ISA.
- The IAFC shall promptly inform the ISA of any matters that may affect bands allocated to the amateur services, particularly the amateur satellite service.
- The IAFC shall work closely with the AMSAT Groups and national IARU Societies as appropriate while maintaining consistent contact with the ISA and the AMSAT Groups, via Internet.
- The IAFC will be expected to attend the Annual IARU International Satellite Forum and such other meetings as agreed to, or directed by, the ISA from time to time. However all travel and other

IARU-R1

expenses associated with such meeting attendance must be budgeted for in advance and is subject to approval of the ISA who is responsible for the budget.

## **3.5 RELEVANT IARU REGION-1 RECOMMENDATIONS**

### **3.5.1 Recommendation CT08\_C5\_Rec01**

(Paper CT08\_C5\_03 Support for Satellite Frequency Coordination)

Member Societies are recommended to work closely with the IARU Satellite Adviser and his Advisory Panel, and with their national administrations, with respect to requests for satellite frequency coordination originating in their respective countries,

### **3.5.2 Recommendation CT08\_C5\_Rec02**

(Paper CT08\_C5\_03 Support for Satellite Frequency Coordination)

Member Societies are recommended to promote the proper use of amateur frequencies consistent with the international Radio Regulations, with a view toward maintaining the integrity of the amateur service and its frequency.

### **3.5.3 Recommendation CT08\_C5\_Rec22**

(Paper CT08\_C5\_16 Increased Amateur Satellite Service 2 Metre Usage)

The presence of interfering non-amateur signals in the 145.80-146.00MHz part of this band, in many parts of the world, is well documented. To prevent the retransmission of interfering terrestrial signals, satellites in the Amateur Satellite Service that plan to use the 145MHz Amateur band for transponders, are encouraged to use this band for downlink (satellite to ground) modes only, regardless of modulation type

### **3.5.4 Recommendation CT08\_C5\_Rec25**

(Paper CT08\_C5\_17 3400MHz Amateur Satellite Allocation)

- National Societies should take all necessary steps in seeking 3400-3410MHz allocations on a Secondary non-interference basis as quickly as possible.
- All Societies should explicitly include the Amateur Satellite Service (both S-E and E-S) in such requests on the basis that many years of terrestrial and EME operations (notably in the CEPT area) have not resulted in interference reports from other users.
- National Societies and IARU-R1 should collaborate more closely to assist those Societies who in the past have not been able to achieve such allocations.
- Societies should collectively obtain a critical mass of national allocations so that footnotes in regional allocation tables can be extended or acquired that include the Amateur Satellite Service
- IARU-R1 to prioritise this band and to take active steps in support of these goals

### **3.5.5 Recommendation CT08\_C5\_Rec37**

(Paper CT08\_C5\_37 Amateur Satellite Service Spectrum - Vienna 2007)

It is recommended that all IARU Region 1 societies request that the following additional Amateur Satellite Service bands be studied and considered, perhaps as a package, for a future WRC agenda item:

- 50-51 MHz
- 1240-1250 MHz
- 2300-2330 MHz
- 2390-2400 MHz
- 3400-3410 MHz
- 5650-5670 MHz (Currently Earth-To-Space only)
- 10350-10400 MHz

## 4 IARU-R1 REPEATER COORDINATION

### 4.1 Coordination of repeater activities

Extensive 145 MHz and 435 MHz repeater networks are operational in Western Europe, and activity on 1.3 GHz is growing.

It is highly important that these developments are internationally guided, so that a coordinated approach is followed for the benefit of all IARU Region 1 amateurs.

The aim of repeater networks has been defined as follows (see chapter 3.1., Principles of bandplanning):

- FM repeaters provide a communication service to mobile amateur-stations (including hand-held equipment). In some cases they may be installed to aid the accessibility of stations in mountainous areas.
- They are not intended to make DX contacts possible, and hence their coverage under normal propagation conditions should be limited.
- The number of repeater stations installed should be determined by
- the required regional coverage
- the expected number of intended users
- FM repeaters should not regularly be used as local chat channels for fixed (home) stations. This interferes with their defined use.

Careful bandplanning is required (section 2), as well as timely agreement on the technical specifications of repeaters and equipment used with repeaters (section 7).

The problem of mutual interference (overlapping coverage pattern) makes it mandatory that in neighbouring countries the allocations of locations and especially of frequencies are coordinated.

For this reason at the IARU Region 1 Conference in Miskolc-Tapolca (1978) the following recommendation was adopted:

***Coverage measurements shall be made for repeaters planned to be installed. In cases of international boundary crossing the VHF Managers concerned should co-ordinate repeater coverage.***

A suitable way of presenting the expected coverage, set out in document M/T 59, submitted by ÖVSV, was recommended for this purpose (see PART 2 section 5.2.3)

## **4.2 Repeater coordination: coverage presentation**

### **4.2.1 Introduction**

In the event that signals of repeaters or other un-manned stations could cause interference beyond the boundaries of the country in which they are operating, all designers, constructors and other persons responsible for such stations are obliged to contact the VHF-UHF-SHF Managers of the neighbouring countries concerned, in order to avoid such interference by coordinating channel use.

As far as Austria is concerned, the VHF Manager entered all areas from where repeaters might be operated on a map, so that all repeater problems could be easily be discussed and solutions found. A copy of such a map, a description of the methods used to prepare such a map, as well as proposed general rules for the use of repeaters are given below.

### **4.2.2 General rules for operating via repeaters**

Users of repeaters shall limit their transmissions to the shortest necessary time and the stations in QSO shall not start their transmission before having left some time to give other stations a chance to make "distress calls", if necessary.

### **4.2.3 Recommended methods to prepare coverage map**

Attached as fig. 1 is an example map showing repeater coverage from some locations in Austria. The entries should be made in accordance with CCIR recommendation 370-1.

A full line designates the area where during at least 50 % of the time contacts via repeaters can be made by a mobile station, running 10 Watts into a 5/8 wavelength vertical antenna.

A dotted line designates the area where during 50 % of the time a fixed station with an effective radiated power of 100 Watts can operate via the repeater.

All locations from where under extraordinary conditions contacts could be made (e.g. mountain tops) should also be entered.

For the above delineations normal propagation conditions should be taken; contact possibilities via rare tropospheric conditions or sporadic-E reflections shall be disregarded.

The person(s) responsible for the planned repeater shall prepare a map according to the method outlined above. This map shall be sent to the national VHF Manager for further (international) co-ordination.

(From document M/T 59, submitted by OeVSV at the IARU Region I Conference in Miskolc-Tapolca, 1978)

## 5 IARU-R1 BEACON COORDINATION

### 5.1 IARU R1 beacons: a guide to good practice

Beacon transmitters have long been used to indicate the presence of VHF openings and have contributed significantly to our knowledge of propagation. As the numbers of beacons is increasing rapidly and the amount of spectrum available for them is under pressure it is important that beacon builders are aware of the technical parameters required, the reasons for them and the procedure to be followed to obtain an agreed frequency.

Beacon - A station in the Amateur Service or Amateur-Satellite Service that autonomously transmits in a defined format, which may include repetitive data or information, for the study of propagation, determination of frequency or bearing or for other experimental purposes including construction."

It is not intended that this document should specify the exact purpose of any individual beacon, its power level or the number of beacons in any country, as this should be agreed within the national society concerned. It is also not intended to be applied rigorously to experimental beacons or beacons with a special purpose. It should however apply to the vast majority of VHF/UHF/Microwave beacons for propagation monitoring purposes, as designated by the beacon sections of the bandplans.

#### 5.1.1 Coordination procedure

The existing requirement for co-ordination of regional beacons will be retained. For non-coordinated beacons the beacon proposal should be agreed with the national society (with consultation with neighbouring societies where appropriate) and a provisional frequency chosen.

If the beacon has an ERP of greater than 10W then the frequency should be submitted to the IARU Region 1 VHF beacon co-ordinator to check for potential interference problems. Societies should provide regular and frequent updates to the IARU R1 Beacon coordinator. Beacons or changes to beacons which are not notified to the coordinator forfeit their arbitration rights in any coordination dispute.

#### 5.1.2 Local Beacons:

In the microwave bands, local beacons, which should be 10W ERP max, may preferably be placed in the x.750-x.800MHz range of the relevant narrowband segment, adjacent to, but outside of the exclusive propagation beacon segments. In this range, the lower powers will permit greater frequency reuse. This permits traditional propagation beacon frequencies to be used more efficiently and minimise cases of local/mutual interference. National societies should inform the IARU R1 Beacon coordinator of such local beacons and national bandplan use.

#### 5.1.3 Transmission mode

Amplitude or Frequency shift keying (A1A or F1A) may be used according to the scheme described in PART 3 Section 11. The beacon radiates on its nominal frequency during the period where no information is transmitted. It then moves to "space", 250/400Hz below and then keys back to nominal ("mark") while transmitting its information. In this way the transmission sounds like A1A in a SSB receiver set to receive USB.

#### 5.1.4 Frequency spacing

All coordinated and notified beacons should operate within the beacon segment of the band plan and be on a frequency which is in accordance to the table below. In bands above 1.3GHz, half the frequency spacing defined below be used as an offset in frequency coordination disputes (Vienna 2007).

## IARU-R1

Band	50 MHz	70 MHz	145 MHz	435 MHz	1.3 GHz	2,4 to 10GHz	24 to 47 GHz
Frequency ppm	4	2.8	1.4	1.0	0.8	TBA	TBA
Tolerance Hz	200	200	200	400	1000		
Spacing between beacons - kHz	1	1	1	1	2-3kHz	5kHz	10kHz
F1A Frequency shift - Hz	250	250	400	400	400	400	400
Frequency at "space" - Hz	nominal - 250	nominal - 250	nominal - 400	nominal - 400	nominal - 400	nominal -400	nominal -400

TBA = To Be Agreed at a future conference

## 5.2 Transatlantic beacon project

At the IARU Region 1 Conference in Tel Aviv 1996 a proposal from URE for a coordinated project whereby beacons at the (North-)West-coast of European countries would be installed in order to test the possibilities of 145 MHz propagation over the Atlantic Ocean, resulted in a recommendation, unanimously accepted by the Conference :

*To help investigate VHF transatlantic propagation, Member Societies are encouraged to participate in an IARU Region 1 co-ordinated programme to establish "Conjugate Beacons" in the 145 MHz band. (These would be similar to the conjugate beacons in the HF bands, emitting sequential signals which are repeated.)*

To help manage this project, a co-ordinator is required.

The tasks of this Beacon Project Co-ordinator will be:

- To make contact with the IARU Region 1 and Region 2 VHF/UHF Beacon Co-ordinators and to make contact with societies/amateurs in Region 1 and Region 2 who are interested in participating in this programme.
- To consult with technical experts with the aim of establishing the technical specifications of the beacons.
- To liaise and co-ordinate between groups building beacons and also those build listening equipment.
- To collect the results of the experiments and to report them to IARU Region 1.

This action of IARU Region 1 should be communicated to IARU Region 2 with the request that they consider similar action.



## 5.3 Synchronised 50 MHz Beacon Project (Varna 2014)

### 5.3.1 Introduction

The 2011 IARU Region-1 General Conference in Sun City agreed to a new Synchronised Beacon Project (SBP) as part of its revisions to the 50MHz band plan. This required the existing beacons to migrate by August 2014 to 50.4-50.5 MHz in order to leave space for the new system at the bottom of the 50MHz band. As agreed at the Vienna Interim meeting in 2013, the basic parameters for beacons in the SBP are 1kHz frequency spacing, 1 minute CW/MGM and a 4 minute repeat period.

At the 2014 IARU Region-1 General Conference in Varna 2014, the migration of Region-1 50 MHz beacons was reviewed and noted as progressing (with good propagation reports), but not yet achieved completely. The deadline for migration of the remainder was extended to 31 December 2015, noting that the default for QSY is usually +400 kHz unless a specific request is sent to the IARU Region 1 beacon coordinator.

Furthermore it was also agreed that:

- The coordination of new beacons below 50,4 MHz shall no longer be possible, except for the members of the Synchronised Beacon Project (SBP)
- The Synchronised beacons will now use – ‘once every 5 minute’ slots, instead of ‘once every 4 minutes’

Member Societies are invited to participate in the pilot programme for the SBP. The paper VA14\_C5\_14 will be used as an implementation guide and an initial pilot scheme demonstration. The societies are invited to consider the best locations for SBP (e.g. an existing site or new strategic site). Region 2 and Region 3 will be informed of progress should they wish to start implementing their own beacon multiplexes.

### 5.3.2 50 MHz synchronised not transmitting in their timeslot

Landshut 2017

50 MHz Synchronised beacons may optionally also transmit on 50.4xx when not transmitting in their 50.0xx synchronised scheme time slot.

- If they use this dual-frequency option, the beacon callsign on each frequency should be slightly different to assist reception and reporting systems. For example, to append /S and /B onto the callsign to indicate Synchronised and ordinary Beacon frequency respectively
- Synchronised Beacons should detect loss/failure of GPS and mute transmissions on their synchronised frequency assignment (50.0xx). However, they remain free to transmit on their (optional) 50.4xx assignment (where they may revert to a CW-only to indicate the problem)
- Consider the advantages of adaptive MGM and remote control for propagation events
- 50 MHz users and propagation experts are encouraged to propose multiplex sequences, with due consideration for access to remote beacon locations/re-programming
- Both transmit and receive software should be flexible to support the above including for example the use of more than one-time slot, if a multiplex is sparse during roll out

## 6 IARU-R1 CERTIFICATES AND MEDALS

IARU Region 1 can recognize meritorious performance in the wide field of amateur activities by awarding

- an IARU Region I certificate
- an IARU Region I medal.

With respect to the amateur activities on the VHF/UHF/SHF bands the following recommendations are relevant.

At the IARU Region 1 Conference in Folkestone (1961) the following resolution was adopted:

*It is recommended that the Executive Committee of IARU Region I issue a certificate to those amateurs within Region I who make first QSO's by unusual modes of propagation, such as meteor-scatter, sporadic-E and moonbounce.*

At the IARU Region 1 Conference in Malmo (1963) the following additional recommendation was adopted<sup>(2)</sup>:

*The Chairman of the VHF/UHF/Microwave Committee is authorized to request the IARU Region 1 Executive Committee to issue Region 1 certificates for special VHF/UHF/SHF performances.*

### 6.1 DB6NT

At the interim meeting of the IARU Region 1 VHF/UHF/Microwaves committee in Vienna 1995 it was decided to propose to the Executive Committee to issue the Region 1 Medal to Michael Kuhne, DB6NT: *for his outstanding contributions to the promotion of microwave activities. He not only is a keen microwave dx-er on all bands up to 245 GHz but has published his designs, allowing other amateurs to construct microwave equipment.*

The executive Committee supported this proposal and the Medal and Certificate were presented to DB6NT by PA0EZ at the 1995 Friedrichshaven International Meeting

### 6.2 S53MV

The Executive Committee of IARU Region 1 has at its April 1999 Meeting decided to offer the IARU Region 1 Medal to Matjaz Vidmar, S53MV:

*in recognition of his contributions to amateur radio in the field of satellites, microwaves and digital communications.*

The medal and certificate were presented by PA0EZ to representatives of the Slovenian Society at an official ceremony at the Region 1 Conference in Lillehammer 1999.

---

<sup>2</sup> Wording brought in accordance with the IARU Region 1 Constitution adopted at the IARU Region 1 Conference in Noordwijkerhout (1987).

### **6.3 National VHF/UHF/ $\mu$ Waves awards and certificates**

A large number of awards and certificates are issued by the member societies in the various countries in Region I, inter alia for achievements on the VHF/UHF/Microwaves bands. The official opinion of IARU Region 1 is that it would be best to have a restricted number of worthwhile awards/certificates, as can be judged from the following adopted recommendations:

The increasing number of awards and contests in Region I is viewed with deep concern and it is recommended that member societies limit the number of such awards and contests in the best interests of amateur radio. (Bad Godesberg, 1958)

The number of awards and certificates, at present in circulation, is not in the best interests of amateur radio. It is recommended to place the matter before the IARU with a view to the preparation of a list of awards in good standing which could bear the official approval of the IARU. (IARU Region 1 Conference in Folkestone, 1961)

In order to enable VHF Managers/VHF Committees to inform the active VHF/UHF/Microwaves amateurs in their countries on the available awards and certificates, the following recommendation<sup>(3)</sup> was adopted at the IARU Region 1 Conference in Malmö (1963):

All VHF/UHF/Microwaves Managers are requested to send a list of the VHF/UHF/Microwaves certificates available in their country, with all relevant data, to the Chairman of the VHF/UHF/Microwaves Committee, in order to enable him to issue a complete list.

#### **6.3.1 Note**

In view of the two first recommendations set out on this page, it should be self-explanatory that some screening has to be applied, and that only worthwhile certificates/awards, as e.g. issued by member societies, should be listed.

In order to make it easier for amateurs to apply for a certificate or award, at the IARU Region 1 Conference in Malmö (1963) the following recommendation was adopted:

***Bearing in mind the difficulty and expense of sending QSL cards with applications for certificates it is recommended that all member societies of IARU Region shall issue certificates on the production of a declaration signed by the Traffic Manager or QSL Manager of the member society in the residence country of the applying amateur.***

In view of some questions that arose with the counting for "Number of Countries Worked" certificates, at the IARU Region 1 Conference in Brussels (1969) the following recommendation was adopted:

***VHF/UHF/Microwaves Certificates: For the issue of certificates concerning countries worked the ARRL DXCC list of countries shall be used.***

---

<sup>3</sup>Wording brought in accordance with the IARU Region 1 Constitution adopted at the IARU Region 1 Conference in Noordwijkerhout (1987)

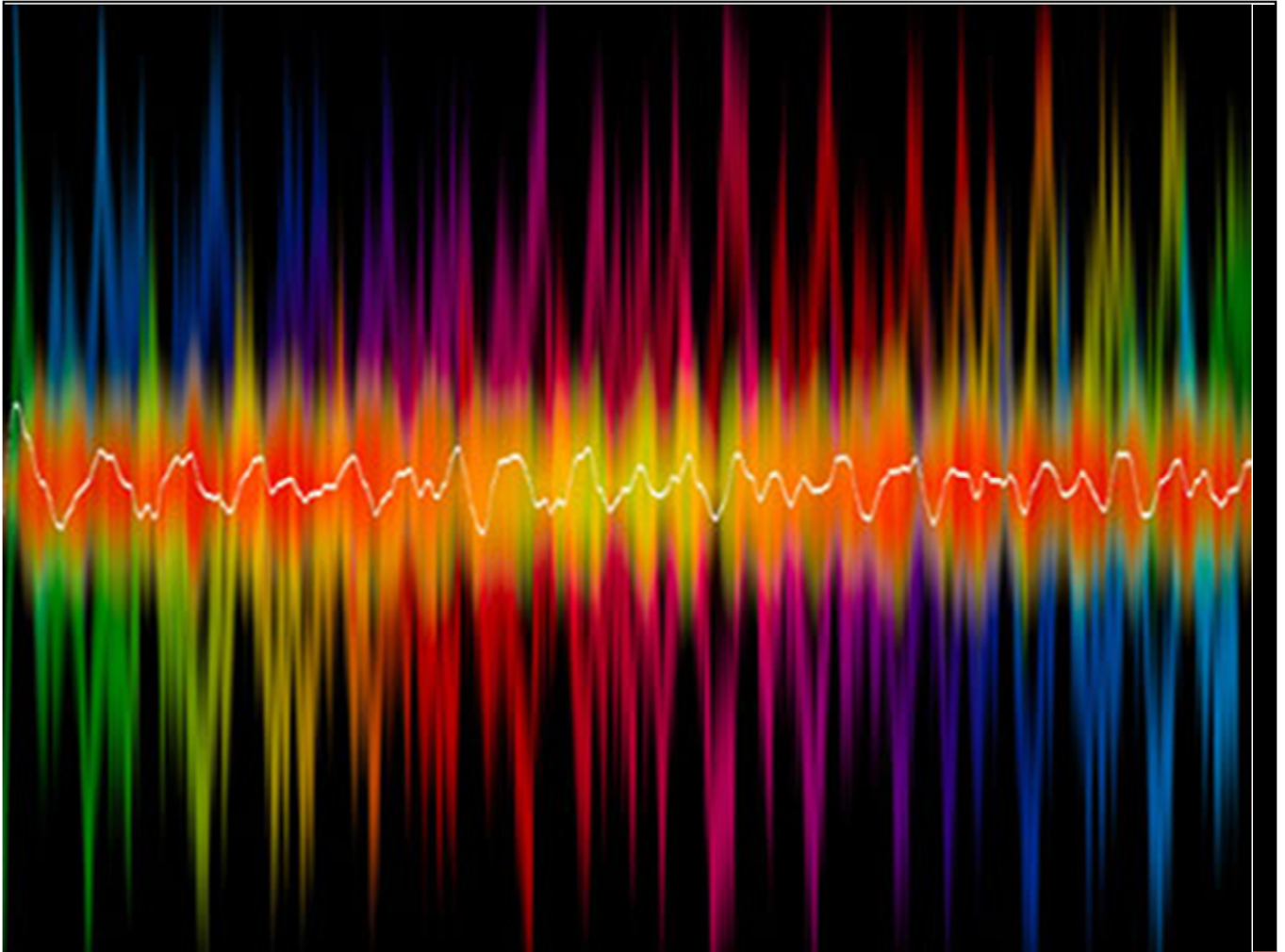

# **PART 2**

## **BANDPLANNING**

# 1 IARU REGION 1 BANDPLANS

## 1.1 Introduction

### 1.1.1 General

On the following pages are the official IARU Region 1 band plans currently valid for the 50 MHz, 70 MHz, 145 MHz, 435 MHz and the microwave bands are set out.

In accordance with the policy outlined in PART 3 section 1 only carefully considered modifications and/or additions have been made during the tri annual IARU Region 1 Conferences.

VHF Managers should give maximum publicity to the adopted band plans. In view of the many newcomers, regular repetition of the publication of the band plans is advisable.

Member Societies, and particularly their VHF Managers or VHF Committees, should strongly promote adherence to the adopted band plans by all VHF/UHF/Microwaves amateurs in their country.

The following notes are referring to the Usage column in the band plan. Operators should take notice of these agreements which are made for operating convenience, but no right to reserved frequencies can be derived from a mention in the Usage column or from the following notes.

The users should be aware that these band plans are generic for all member states of IARU-R1.

They can be more detailed in some Member states due to practical reasons and/or legislation. Therefore we advise to look also to the bandplanning of the country of the operator.

### 1.1.2 European table of frequency allocations

In order to develop European common positions and proposals to harmonise within Europe the efficient use of the radio spectrum, CEPT endorsed in 2002 the principle of adopting a harmonised European Table of Frequency Allocations and Applications (also called the ECA table) to establish a strategic framework for the utilisation of the radio spectrum in Europe.

You will find this Table on: <https://www.ecodocdb.dk/download/2ca5fcbd-4090/ERCREP025.pdf>

This table contains different footnotes, numbered as ECAxx

Some of them are important for us (see the footnotes in the bandplanning).

We give here a summary of the most important ones:.....

Some of them are important for us( see the footnotes in the bandplanning).

We give here a summary of the most important ones:

- **ECA9** - CEPT administrations may authorise all or parts of the band 69.9-70.5 MHz to the amateur service on a secondary basis
- **ECA17** - In the sub-bands 5755-5765 MHz, 10.36-10.37 GHz, 10.45-10.46 GHz the amateur service operates on a secondary basis. In making assignments to other services, CEPT administrations are requested wherever possible to maintain these subbands in such a way as to facilitate the reception of amateur emissions with minimal power flux densities.
- **ECA23** - In the sub-bands 5660-5670 MHz (earth to space), 5830-5850 MHz (space to earth) and 10.45-10.50 GHz the amateur-satellite additionally operates on a secondary and non interference basis to other services. In making assignments to other services, CEPT administrations are requested wherever possible to maintain these allocations in such a way as to facilitate the reception of amateur emissions with minimal power flux densities.
- **ECA35** - In Europe the band 75.5-76 GHz is also allocated to the Amateur and Amateur Satellite services.

More info can also be found on the website [European Communications Office](#)

**1.2 50 – 54 MHz Band plan**

Frequency	Maximum Bandwidth	Mode (a)	Usage
50.000  50.100	500 Hz	Telegraphy exclusive (except Beacon Project)	50.000 - 010 Region-1 * 50.010 - 020 Region-2 * 50.020 - 030 Region-3 * * Reserved for future Synchronised Beacon Project (b)  50.050 CW future International centre of activity 50.090 CW Intercontinental centre of activity
50.100  50.200 50.200	2700 Hz	SSB Telegraphy	International preferred 50.100 - 130 Intercontinental section 50.110 Intercontinental centre of activity(c)  50.130 - 200 international section 50.150 International centre of activity
50.200  50.300 50.300	2700 Hz	SSB Telegraphy	General usage 50.285 for crossband
50.300  50.400 50400	2700 Hz	MGM Narrowband Telegraphy	50.305 PSK Centre of activity  50.310 - 320 EME centre of activity 50.320 - 380 MS centre of activity
50400  50.500 50.500	1000 Hz	MGM Telegraphy	Beacons exclusive
50.500  52.000 52.000  54.000	12 kHz	All Modes (g)	50.510 SSTV 50.540 - 580 Simplex FM Internet Voice Gateways 50.550 Image frequency 50.620 - 750 Digital communications 50.630 DV calling 51.210 - 390 FM/DV Repeater Inputs, 20 kHz spacing (e) 51.410 - 590 FM/DV Simplex (f) 51.510 FM calling frequency 51.810 – 990 FM repeaters output channels, 20 kHz spacing (e)
52.000 52.000 54.000	500 KHz	All modes	(f)

DV: digital voice

**1.2.1 Notes: bandplan**

- a. legacy usage for MGM is accepted, but effort should be made to move this to 50,300 – 50,400 MHz. Usage by operators may vary due to restrictions on national allocations

**1.2.2 Notes: Usage**

For the numbering of FM telephony see PART 2 section 1.4

In those countries within the European part of IARU Region 1 where it is allowed to set up FM repeaters on 50 MHz, the indicated channels are recommended in order to establish a commonality.

In those countries where the National Authorities do not permit repeaters to operate with output frequencies above 51 MHz, repeater output frequencies may be 500 kHz below the repeater input frequencies. (Tel Aviv 1996).

## IARU-R1

### Footnotes:

- b. The intercontinental DX calling frequency 50.110 MHz should not be used for calling within the European part of Region 1 at any time.
- c. deleted.
- d. For the specification of FM telephony PART 3 section section 8.1
- e. This segment is for simplex use only with no Digital Voice gateways permitted. Embedded data traffic is allowed along with Digital Voice. DV users should check that the channel is not in use by other modes
- f. In those Region 1 countries where 52 - 54 MHz (or parts thereof) is allocated, its use should be planned on the basis of up to 4 x 500 kHz blocks which may be sub-divided to suit digital applications. Amateurs using digital transmission methods must also ensure that their transmissions do not spread beyond band edges.
- g. Experiments using wider bandwidth digital modes may take place in the 50 MHz band within the 50.5 - 52 MHz segment where local conditions permit, on the basis it does not cause interference to other users (including narrowband/beacon use)
  - noting that potential options for this include around 50.6, 51.0 or 51.7 MHz and maximum bandwidth of around 50 kHz
  - That Member Societies encourage such 50 MHz digital experiments to support innovation and development of the band and report results back to IARU Region 1

### 1.3 70.0 – 70.5 MHz Band plan

The 70MHz band is increasingly recognised as being appropriate for amateur allocations. In the CEPT area this progress is now recognised in the European Table of Frequency Allocations by Footnote ECA9 which states:

**ECA9** CEPT administrations may authorise all or parts of the band 69.9-70.5 MHz to the amateur service on a secondary basis

In addition it is worth noting that there is some experimental access on a national basis in the range 69.90 - 70.0MHz in cases where 70MHz is not available.

References:

- [1] European Allocation Table: <http://www.erodocdb.dk/Docs/doc98/official/pdf/ercrep025.pdf>  
 [2] <http://www.70MHz.org> has a useful list of current allocations and permits

Frequency (MHz)	Maximum Bandwidth	MODE	Usage
70.000	1000Hz	TELEGRAPHY MGM	Coordinated Beacons(a)
70.090	1000Hz	BEACONS	temporary and personal beacons
70.100	2700Hz	TELEGRAPHY SSB MGM	70.185 Crossband center of activity 70.200 Telegraphy/SSB calling 70.250 MS calling
70.250	12kHz	AM / FM (b)	70.260 AM/FM calling 70.270 MGM centre of activity
70.294	12kHz	FM CHANNELS, 12.5 kHz spacing	70.3125 Digital communications 70.3250 Digital communications  70.4500 FM calling 70.4625 70.4750 70.4875 Digital communications
70.500			

#### 1.3.1 Notes: BANDPLAN

Footnotes:

- Refer to Beacons Chapter for coordination of beacons (PART 2 Section 6)
- Usage by operators may vary due to restrictions on national allocations

#### 1.3.2 Notes: Usage

Footnotes: none



**1.4 144 – 146 MHz Bandplan**

Frequency (MHz)	Maximum Bandwidth	MODE	USAGE
144.000	2700 Hz	ALL MODE	Satellites (downlinks only) (s) (Varna 2014)
144.025			
144.025	500 Hz	Telegraphy (a)	144.050 Centre of activity
144.100			144.100 Random MS(m)
144.100	500 Hz	Telegraphy & MGM	144.110–144.160 EME MGM (i)
144.150	2700 Hz	Telegraphy & SSB & MGM	144.195-144.205 Random MS SSB (m)
144.150			144.300 SSB Centre of activity
144.400			
144.400	500 Hz	Telegraphy MGM	Beacons exclusive (b)
144.490	500 Hz	EMGM	Experimental MGM
144.491			
144.493			
144.500	20 kHz	All mode (f)	144.500 Image mode centre (SSTV, Fax,..)
144.794			144.600 Data centre of activity(MGM,RTTY,..) 144.750 ATV talk back
144.794	12 KHz	MGM (h) Digital Communications	144.800 APRS
			144.8125 DV Internet voice gateway
			144.8250 DV Internet voice gateway
144.9625			144.8375 DV Internet voice gateway
			144.8500 DV Internet voice gateway
			144.8625 DV Internet voice gateway

## IARU-R1

144.975 145.194	12kHz	FM / Digital voice	Repeater Input exclusive (c)
145.194 145.206	12kHz	FM / Digital voice (i)	Space communication (p)
145.206 145.5625	12kHz	FM / Digital voice (i)	145.2375 FM Internet Voice Gateway 145.2875 FM Internet Voice Gateway 145.3375 FM Internet Voice Gateway  145.375 digital voice calling 145.500 FM calling
145.5625 145.5750	12kHz	FM / Digital voice	Repeater Output exclusive (c, d)
145.7935 145.794	12kHz	FM / Digital voice (i)	Space communication (p)
145.794 145.806	12kHz	FM / Digital voice (i)	Space communication (p)
145.806 146.000	12kHz	ALL MODE (e)	Satellite exclusive

### 1.4.1 Notes: BANDPLAN

The following notes are part of the officially adopted IARU Region 1 bandplan, and all member societies should strongly promote adherence to the recommendations made in these notes.

General:

- i. In Europe no input or output channels of telephony repeaters shall be allowed to operate between 144.000 and 144.794 MHz.

Footnotes:

- a. Telegraphy is permitted over the whole band, except in the beacon band; Telegraphy exclusive between 144.000 - 144.110 MHz. (except satellite output downlink to earth)
- b. Refer to Beacons Chapter for coordination of beacons in the beacon sub-band Section-
- c. For technical standards on FM and repeaters PART 3 section 8.2  
If there is a real need for more repeater channels it is recommended that Societies or Repeater Groups consider setting up a repeater system on the higher frequency band(s).  
Further to this subject the following recommendation was adopted in. De Haan, 1993:  
For the numbering of FM telephony channels, see annex 2 to this section.
- d. Established simplex frequencies on repeater output channels may be retained.
- e. In view of the important public relations aspect of amateur satellite activities, it was decided at the IARU Region 1 Conference in Miskolc Tapolca (1978) that:
  - i. AMSAT will be allowed to use the band 145.8 - 146.0 MHz for amateur satellite activity.
  - ii. This decision was re-confirmed at the IARU Region 1 Conference in Brighton (1981).
  - iii. see also footnote p
- f. No unmanned stations shall use the all-mode segment, except for linear transponders and ARDF beacons. (Tel Aviv 1996, San Marino 2002)
- i. This segment is for simplex use only with no Digital Voice gateways. Embedded data traffic is allowed along with digital voice. Digital Voice users should check that the channel is not in use by FM.
- j. Amateur Satellite Linear Transponder down-links. Subject to agreement with Region-2 and 3

IARU-R1

### 1.4.2 Notes: Usage

The following notes are referring to the Usage column in the bandplan. As already set out in the introduction to section IIc, in the right amateur spirit operators should take notice of these agreements which are made for operating convenience, but no right to reserved frequencies can be derived from a mention in the Usage column or from the following notes.

Footnotes:

- k. Not used
- l. Not used
- m. See procedures set out in section 1.4
- n. Deleted (Varna 2014)
- o. Not used
- p. For FM voice communications with special stations like manned spacecraft it is recommended to use 145.200 MHz for simplex operation or 145.200/145.800 MHz for split-channel operation (Vienna 1995/Tel Aviv 1996).
- q. It is recognised that in the IARU Region 1 rules for the Championships in Amateur Radio Direction Finding (ARDF) competitions, the frequencies for the unmanned beacons are in the segment 144.500 – 144.900 MHz. These beacons run low power and are on the air only during ARDF events. (Davos 2005)
- r. No transmission shall be made below 144,0025 MHz\* (Varna 2014)

\*so that a necessary guard band is provided at the bottom edge

### 1.4.3 National usage notes

Some countries have existing use at:

- • 144.660-144.690 Linear Transponder Inputs
- • 144.630-144.660 Linear Transponder Outputs

**1.5 430 – 440 MHz**

Frequency MHz	Maximum Bandwidth	MODE	USAGE	
430.000  SUB-REGIONAL (national bandplanning) (d)  431.975	20kHz	ALL MODES	430.025 - 430.375  430.400 - 430.575  430.600 - 430.925  430.925 - 431.025  431.050 - 431.9875  431.625 - 431.975	FM repeater output-channel freqs (F/PA/ON), 12.5 kHz spacing, 1.6 MHz shift (f)  Digital communication link channels (g) (j)  Digital communications repeater channels (g) (j) (l)  Multi mode channels (j) (k) (l)  Repeater Input Region 1, 12.5 kHz spacing, 7.6 MHz shift (f).  Repeater input channel freqs (F/PA/ON), 12.5 kHz spacing, 1.6 MHz shift (p)
432.000 432.025	500Hz	Telegraphy (a)		EME
432.000  432.100	500Hz	Telegraphy (a) MGM	432.050  432.088	Telegraphy centre of activity  PSK31 centre of activity
432.100  432.400	2700Hz	Telegraphy SSB MGM	432.200  432.350  432.370	SSB centre of activity  Microwave talkback centre of activity  FSK441 random calling
432.400 432.490	500Hz	Telegraphy, MGM		Beacons exclusive (b)
432.491 432.493	500 Hz	EMGM		Experimental MGM
432.500  432.975	12kHz	ALL MODES	432.500  432.600 - 432.9875	NEW APRS FREQUENCY  REPEATER INPUT REGION 1 25 kHz spacing, 2 MHz shift  In the UK repeater OUTPUT channels.

## IARU-R1

433.000  433.375	12 kHz	FM Digital voice Repeater (p)	433.000 - 433.3875  433.000 - 433.375	Repeater Input Region 1, 12.5 kHz spacing, 1.6 MHz shift (p).  Repeater Output only in the UK, 25 kHz spacing, 1.6 MHz shift.
433.400  433.575	12 kHz	FM Digital voice (f) (o)	433.400 433.450 433.500	SSTV(FM/AFSK) digital voice calling FM calling  SIMPLEX CHANNELS, 25 kHz spacing, ( Channel freq 433.400 -- 433.575 MHz)
433.600  434.000	20kHz	ALL MODES	433.625 - 433.775  434.000	Digital communications channels (g) (h) (i)  Centre frequency of digital experiments as defined on note (m)  LORA (p)
434.000  434.594	12kHz (c)	ALL MODES ATV (c)	434.450 - 434.575	Digital communications channels (by exception !! ) (i) (m)
434.594  ATV (c) & FM  434.981	12kHz (c)	ALL MODES	434.600 - 434.9875  434.600 - 434.975	Repeater Output Region 1, 12.5 kHz spacing, 1.6 or 2.0 MHz shift (p)  Repeater Input only in the UK, 25 kHz spacing, 1.6 MHz shift.
435.000  438.000	20kHz (c)	Satellite service & ATV (c)		
438.000  ATV (c) & SUB- REGIONAL (national bandplanning ) (d)  440.000	20kHz (c)	ALL MODES	438.025 - 438.175  438.200 - 438.525  438.550 - 438.625  438.650 - 439.5875  439.800 -- 439.975	Digital communications channel frequency (g)  Digital communications repeater channels (g) (j) (l)  Multi-mode (j) (k) (l)  Repeater Output Region 1, 12.5 kHz spacing, 7.6 MHz shift (f).  Digital communications link channels (g) (j)

**1.5.1 Notes: BANDPLAN**

The following notes are part of the officially adopted IARU Region 1 bandplan, and all member societies should strongly promote adherence to the recommendations made in these notes.

- a) In Europe no input or output channels of telephony repeaters shall be allowed to operate between 432 and 433 MHz ( From 1-1-2004 those frequencies are between 432.000 and 432.600 MHz )
- b) FM telephony channels and Repeaters are specified in chapter 7.2.1
- c) ATV Repeater outputs are not permitted in the 435MHz band (Varna 2014)

**Footnotes**

- a. Telegraphy is permitted over the whole narrow-band DX part of the band; Telegraphy exclusive between 432.000 - 432.100 MH. PSK31, however, can be used as well in this segment
- b. Refer to Beacons Chapter for coordination of beacons in the beacon sub-band  
See Section 5.1.1
- c. ATV operators should be encouraged to use the microwave allocations where available, but may continue to use the 435 MHz band. In case of interference between ATV and the Amateur Satellite Service, the Satellite Service shall have priority.

Any remaining legacy wideband ATV usage in the 435MHz band should be phased out in favour of narrower bandwidth, more compatible, modes such as DATV or SATV

For ATV transmissions National societies should provide guidance to their members on the exact frequencies to be used, with due consideration of the interests of other users (Varna 2014)

- d. The words "Sub-regional (national) bandplanning" appearing in IARU Region 1 VHF/UHF/Microwave bandplans mean the following:

In bands and sub-bands not available throughout Region 1, band-planning should be coordinated on a sub-regional basis between the countries where those bands and sub-bands are allocated to the Amateur Service. The words "national bandplanning" refer to bands/segments which are available only in a single country (such as the 70 MHz band allocation), or only in a few widely separated countries.(Torremolinos 1990)

- e. Not used  
Embedded data traffic is allowed along with digital voice. Digital Voice users should check that the channel is not in use by other modes

**1.5.2 Notes: Usage**

The following notes are referring to the Usage column in the bandplan. As already set out in the introduction to section IIc, in the right amateur spirit operators should take notice of these agreements which are made for operating convenience, but no right to reserved frequencies can be derived from a mention in the Usage column or from the following notes ( except where 'exclusive' is mentioned).

**Footnotes**

- f. The HB/DL/OE wide-shift repeater system, already in use for a long time, is valuable with a view to a better utilisation of the whole band. Hence IARU Region 1 endorses the system.  
This also applies for the French repeater channel system, also adopted by the Netherlands and Belgium, which IARU Region 1 supports as a useful measure to fill a hitherto unused part of the band.
- g. In the Usage section of the 435 MHz bandplan the following frequency segments have been designated for digital communications:
  - i. 430.544 - 430.931 MHz      Extension of the 7.6 MHz repeater system input  
for digital communication
  - 438.194 - 438.531 MHz      Output channels for the above
  - ii. 433.619 - 433.781 MHz
  - 438.019 - 438.181 MHz
  - iii. 430.394 - 430.581 MHz      For digital communication links
  - 439.794 - 439.981 MHz      For digital communication links

## IARU-R1

With due regard to the band allocated to the Amateur Service by the national Administration, the interests of other users, possible interference from e.g. ISM, the specific digital technique or system to be accommodated etc., a sub-regional, or national choice may be made within the above segments.

- h. In those countries where 433.619 - 433.781 MHz is the only segment of the 435 MHz band available for digital communications, modulation techniques requiring a channel separation exceeding 25 kHz should not be used. If different or incompatible use of this part of the frequency spectrum is contemplated in neighbouring countries, this use should be coordinated between the countries concerned with the aim of avoiding harmful interference.
- i. On a temporary basis, in those countries where 433.619 - 433.781 MHz is the only segment of the 435 MHz band available for Digital Communications:
  - i. Channels with centre frequencies 432.500, 432.525, 432.550, 432.575, 434.450, 434.475, 434.500, 434.525, 434.550 and 434.575 may be used for digital communications.
  - ii. Use of these channels must not interfere with linear transponders.
  - iii. Modulation techniques requiring a channel separation exceeding 25 kHz must not be used on these channels. (De Haan, 1993)
- j. At the IARU Region 1 Conference in Torremolinos (1990) the following recommendation was adopted regarding the segments for repeaters and links, shown in footnote g:

For a repeater/link to be installed within 150 km of a national border, the member society should co-ordinate the frequency allocation and the technical (system) data with the member societies in neighbouring countries. Special attention should be paid to the common good practice of using directional antennas and the minimum power necessary.

As a matter of course this agreement is also valid for any link experiments carried out on the multi-mode channels in the segment 438.544--438.631 MHz. (De Haan, 1993).

- k. These multi-mode channels are to be used for experimenting with new transmission technologies (De Haan, 1993)
- l. In the United Kingdom the use of low-power speech repeaters on repeater channels in the segment 438.419--438.581 is allowed. Where necessary, frequencies will be coordinated with neighbouring countries (De Haan, 1993).
- m. Experiments using wide band digital modes may take place in the 435 MHz band by staying in the segment. in those countries that have the full 10 MHz allocation.
- n. Common frequencies for Simplex (FM) Internet voice gateways are: 433.950, 433.9625, 433.975, 433.9875, 434.0125, 434.025, 434.0375, 434.050 MHz (Cavtat 2008)
- o. All Voice repeater channels may use FM or Digital Voice modes. (Cavtat 2008)
- p. two dial frequencies for LORA APRS:
  - 433.775 LoRa-1 (from Node to Gateway BW 125kHz)
  - 433.900 LoRa-2 (from Gateway to Node , for messages, BW 125kHz)

### 1.5.3 National usage notes

- q. Some countries have existing use at:

432.500-432.600	Linear	Transponder	Inputs
432.600-432.800	Linear	Transponder	Outputs
439.9875	POCSAG (Paging)		

- r. In countries without access to the full 70 cm band, the following 12,5 kHz repeater channels with a 1.6 MHz separation between uplink and downlink can be implemented:
  - a. Input Frequencies (uplink) 431,225 – 431,600 MHz
  - b. Output Frequencies (downlink) 432,825 – 433,200 MHz

This needs international coordination if necessary

### 1.5.4 DATV & SATV in the 435 MHz Band (Varna 2014)

As the national 70cm allocations vary considerably, it is not possible in the VHF Handbook to specify exact centre frequencies for DATV/SATV operation – but it should be where its bandwidth is compatible with other uses.

#### IARU-R1

If the 435-438MHz amateur satellite section is used for ATV, it shall be on the following basis:

- ATV (like Voice) Repeater outputs are not permitted
- ATV Internet gateways are not permitted
- ATV Repeater inputs are permitted (eg for cross band usage)
- ATV Simplex usage is permitted
- Transmission times by ATV users should be as short as possible

Any usage should also be compliant with the Region 1 Technical Recommendations for DATV/SATV and in particular the maximum bandwidth.

Centre frequencies of ATV usage in the amateur satellite section shall be chosen to place its bandwidth at the upper end of the amateur satellite section



**1.6 1200 – 1300 MHz Bandplan**

Frequency MHz	Maximum Bandwidth	MODE	USAGE	
1240.000 1240.500	2700 Hz	ALL MODE	(reserved for future)	
1240.500 1240.750	500Hz	Telegraphy MGM	Beacons (reserved for future)	
1240.750 1241.000	20kHz	FM Digital voice	(reserved for future)	
1241.000 1243.250	20kHz	ALL MODE	1240.000-1241.000 1242.025-1242.250 1242.275-1242.700 1242.725-1243.250	Digital communications Repeater output, ch. RS1 - RS10 Repeater output, ch. RS11 - RS28 Digital communications, ch. RS29 - RS50
1243.250 1260.000	(d)	ATV Digital ATV	1258.150-1259.350	Repeater output, ch. R20 - R68
1260.000 1270.000	(d)	Satellite Service		
1270.000 1272.000	20kHz	All Mode	1270.025-1270.700 1270.725-1271.250	Repeater input, ch. RS1 -- RS28 Digital communication, ch. RS29 -- RS50
1272.000 1290.994	(d)	ATV Digital ATV		
1290.994 1291.481	20kHz	FM Digital voice Repeater INPUT	RM0 (1291.000) -- RM19 25kHz spacing RM19 (1291.475)	
1291.481 1296.000	(d)	ALL MODES	1293.150-1294.350  R20 (1293.150) R68 (1294.350)	Repeater input,
1296.000 1296.150	500Hz	Telegraphy MGM	1296.00-1296.025 <del>1296.138</del>	Moonbounce PSK31 centre of activity
1296.150 1296.800	2700Hz	Telegraphy SSB MGM	1296.200  1296.400-1296.600 1296.500 1296.600  1296.600-1296.700 1296.741- 1296.743 1296.750-1296.800	Narrow-band centre of activity  Linear transponder input Image center (SSTV, Fax etc) Narrowband Data center (MGM, RTTY,..)  Linear transponder output experimental MGM (500Hz) Local Beacon (10W ERP max)

## IARU-R1

<b>1296.800</b> <b>1296.994</b>	500Hz	Telegraphy MGM	Beacons exclusive (b)
<b>1296.994</b> <b>1297.481</b>	20kHz	FM Digital voice Repeater OUTPUT	RM0 (1297.000) 25 KHz spacing RM19 (1297.475)
<b>1297.494</b>       <b>1297.981</b>	20kHz	FM (c)  Digital Voice (e)	SM20 (1297.500)  (25 KHz spacing - SIMPLEX)  1297.500 FM center of activity 1297.725 Digital Voice calling (25 KHz spacing - SIMPLEX) 1297.900-1297.975 Simplex FM Internet voice gateways SM39 (1297.975)
<b>1298.000</b>       <b>1299.000</b>	20kHz	All modes	General mixed analogue or digital use in 25 kHz channels 1298.025MHz (RS1) 1298.975MHz (RS39)
<b>1299.000</b>       <b>1299.750</b>	150kHz	All modes	Arranged as 5 x150kHz channels for high speed Digital Data (DD) usage: Centres: 1299.075, 1299.225, 1299.375, 1299.525, 1299.675 MHz (+/- 75kHz)
<b>1299.750</b>       <b>1300.000</b>	20kHz	All modes	8x25kHz channels (available for FM/DV use) : Centres: 1299.775-1299.975

### 1.6.1 Notes: BANDPLAN

The following notes are part of the IARU Region 1 bandplan for this band, originally adopted during the IARU Region 1 Conference at Noordwijkerhout (1987), and all member societies should strongly promote adherence to the recommendations made in these notes.

At the IARU Region-1 Conference at Cavtat (2008), Recommendation CT08\_C5\_27 was adopted which designated the 1240.0-1240.75MHz segment as an alternative narrowband section and makes a series of recommendations for replanning other parts of the band for DATV and Digital Voice & Data

#### Footnotes

- deleted
- Refer to Beacons Chapter for coordination of beacons in the beacon sub-band Section
- In countries where 1298 - 1300 MHz is not allocated to the Amateur Service (e.g. Italy) the FM simplex segment may also be used for digital communications.
- Bandwidth limits according to national regulations.
- Embedded data traffic is allowed along with digital voice. Digital Voice users should check that the channel is not in use by other modes

### 1.6.2 Notes: Usage

The following note refers to the Usage column in the bandplan. As already set out in the introduction to section IIc, in the right amateur spirit operators should take notice of these agreements which are made for operating convenience, but no right to reserved frequencies can be derived from a mention in the Usage column.

During contests and band openings, local traffic using narrow-band modes should operate between 1296.500 - 1296.800 MHz.

**1.7 2300 – 2450 MHz Bandplan**

Frequency	Maximum Bandwidth	Mode	Usage
<b>2300.000</b> SUB-REGIONAL (national) BANDPLANNING (a)	20 kHz	ALL MODES	2304 - 2306 Narrow band segment in countries where the 2320-2322 segment is not available  2308 - 2310 Narrow band segment in HB
<b>2320.000</b> <b>2320.000</b> <b>2320.150</b>	500 Hz	TELEGRAPHY EXCLUSIVE (c) Telegraphy MGM (c)	2320.000-2320.025 EME <del>2320.138</del> PSK31 centre of activity
<b>2320.150</b> <b>2320.800</b>	2700 Hz	TELEGRAPHY/ SSB (c)	2320.200 SSB centre of activity  2320.750-2320.800 Local Beacons (10W ERP max)
<b>2320.800</b> <b>2321.000</b>		Telegraphy MGM	BEACONS EXCLUSIVE (c)
<b>2321.000</b> <b>2322.000</b>	20 kHz	FM and Digital Voice	VOICE SIMPLEX & REPEATERS (b)
<b>2322.000</b> <b>2400.000</b>		All Modes (b)	2322.000-2355.000 ATV 2355.000-2365.000 Digital communications  2365.000-2370.000 Repeaters 2370.000-2392.000 ATV 2392.000-2400.000 Digital communications
<b>2400.000</b> <b>2450.000</b>		Amateur Satellite Service	2400 - 2402 Narrow band segment in countries where the 2320-2322 segment is not available 2400.500 : centre of activity 2400,800 – 2401,000 Coordinated NB beacons  2427.00 - 2443.00 ATV if no satellite uses this segment

**1.7.1 Notes: BANDPLAN**

- a. The words "Sub-regional (national) bandplanning" appearing in IARU Region 1 VHF/UHF/Microwave bandplans mean the following:

In bands and sub-bands not available throughout Region 1, band-planning should be coordinated on a sub-regional basis between the countries where those bands and sub-bands are allocated to the Amateur Service. The words "national bandplanning" refer to bands which are available only in a single country (such as the 70 MHz band allocation), or only in a few widely separated countries. (Torremolinos 1990)

- b. In countries where the ALL MODES segment 2322 - 2400 MHz is not allocated to the Amateur Service, the FM SIMPLEX & REPEATER segment 2321 - 2322 MHz may be used for digital data transmissions. For the specification of FM see section VIb
- c. In countries where the narrow-band segment 2320 - 2322 MHz is not available, the following alternative narrow-band segments can be used:

IARU-R1

- 2304 - 2306 MHz
- 2308 - 2310 MHz
- 2400 -2402 MHz

### 1.8 3400 -3475 MHz

Frequency	Maximum Bandwidth	Mode	Usage
3400.000	500 Hz	Telegraphy	3400.100 Centre of activity and EME (b)
3400.800		MGM ALL MODE	3400.750-3400.800 Local Beacons (d)
3400.800		MGM	BEACONS ONLY (e)
3400.995		Telegraphy ALL MODE	
3401.000	2700 Hz	ALL MODE	
3402.000		ALL MODE	SATELLITE DOWNLINKS (a) (c)
3410.000		ALL MODE	
3475.000			

#### 1.8.1 Notes: BANDPLAN

Footnotes:

- CEPT footnote ECA17 no longer includes 3400-3410 MHz. However the CEPT ECA Table (ERC Report 25) still includes amateur service as a secondary allocation in 3400-3410 MHz
- EME Centre of Activity has migrated from 3456 to 3400.1MHz to promote harmonised usage and activity
- Amateur Satellite Service is allocated in 3400-3410MHz in Regions 2&3 and in some countries of Region-1.
- 3400.750-3400.800MHz may be designated for Local Beacon use (10W ERP max) by National Societies.
- Refer to Beacons Chapter for coordination of beacons in the beacon sub-band

**1.9 5650 – 5850 MHz Bandplan**

Frequency	Maximum Bandwidth	Mode	Usage
5650.000	2700 Hz	ALL MODES	AMATEUR SATELLITE SERVICE ( up-link)
5668.000			
5668.000	2700 Hz	ALL MODES	5668.200 Narrow band center of activity (a)
5670.000			AMATEUR SATELLITE SERVICE ( up-link)
5670.000		MGM	
5700.000			
5700.000		ATV	
5720.000			
5720.000		ALL MODES	
5760.000	2700 Hz	ALL MODES	5760.200 Narrow band center of activity (a)
5760.000			5760.750-5760.800 Local Beacon (d)
5760.800		Telegraphy MGM	BEACONS ONLY
5760.990			
5761.000		ALL MODE	
5762.000			
5762.000		ALL MODES	(d)
5830.000			
5830.000		ALL MODES	AMATEUR SATELLITE SERVICE (down-link)
5850.000			

**1.9.1 Notes: BANDPLAN**

## Footnotes

- Societies are urged to inform their members that stations should preferably be able to operate in both narrow-band segments.
- 5760.750-5760.800MHz may be designated for Local Beacon use (10W ERP max) by National Societies.
- Refer to Beacons Chapter for coordination of beacons in the beacon sub-band
- Any wideband system shall protect narrowband applications, which have priority

**1.10 10.000 – 10.500 GHz Bandplan**

Frequency GHz	Maximum Bandwidth	Mode	Usage
10.000			
10.150		MGM	
10.150		ALL MODES	
10.250			
10.250		MGM	
10.350		ALL MODES	
10.368			
10.368	2700 Hz	ALL MODES	10.3682 Narrow band center of activity
10.368.800			10368.750-10368.800 Local Beacon (d)
10.368.800 10.368.990			BEACONS ONLY (c)
10.369	2700 Hz	ALL MODES	
10.370			
10.370 10.450		ALL MODES	
10.450		ALL MODES	10.450-10.452 Narrow band modes in countries where 10.368-10.370 is not available
10.500			AMATEUR SATELLITE SERVICE

**1.10.1 Notes: BANDPLAN**

## Footnotes

- In those countries where the narrow-band segment 10368 - 10370 MHz is not available, the segment 10450 - 10452 MHz is suggested as an alternative narrow-bandwidth segment.
- 10368.750-10368.800 may be designated for Local Beacon use (10W ERP max) by National Societies.
- Refer to Beacons Chapter for coordination of beacons in the beacon sub-band Section

**1.11 24.000 – 24250 GHz Bandplan**

Frequency GHz	Maximum Bandwidth	Mode	Usage
24.000		ALL MODES	24.025 Wideband centre of activity (Varna 2014)
24.048			
24.048	2700 Hz	ALL MODES	24.0482 Narrow band centre of activity AMATEUR SATELLITE SERVICE NARROW BAND MODES 24048.750-24048.800MHz Local Beacon (b)
24.048.800			
24.048.800		ALL MODES	BEACONS (c)
24.048.995			
24.049	2700 Hz	ALL MODES	AMATEUR SATELLITE SERVICE & NARROW BAND MODES
24.050			
24.050		ALL MODES	
24.250			

**1.11.1 Notes: BANDPLAN**

## Footnotes

- a. Deleted (Varna 2014)
- b. 24048.750-24049.800MHz may be designated for Local Beacon use (10W ERP max) by National Societies.
- c. Refer to Beacons Chapter for coordination of beacons in the beacon sub-band

**1.12 47.000 – 47.200 GHz Bandplan**

Frequency	Maximum Bandwidth	Mode	Usage
47.000  47.088		ALL MODES	
47.088  47.090	2700 Hz	ALL MODES	47.088200      Narrow band center of activity  AMATEUR SATELLITE SERVICE
47.090  47.200		ALL MODES	



**1.13 75.500 – 81.500 GHz Bandplan**

Frequency	Maximum Bandwidth	Mode	Usage
75.500	2700 Hz	All Mode	AMATEUR SATELLITE SERVICE (Preferred) (a)
76.000			75976.200 MHz : Preferred Narrow band centre of activity
76.000		All Mode	76032.200 MHz :Narrow Band Centre of activity in some countries (not preferred) (b)
77.500			
77.500	2700 Hz	All Mode	77500.200 MHz: Preferred NB centre of activity in countries outside the CEPT area (non-preferred / preferred) (c)
77.501			AMATEUR SATELLITE SERVICE
77.501		All Mode	ALL MODES (Preferred segment)
78.000			
78.000		All Mode	ALL MODES (not preferred)
81.500			

**1.13.1 Notes: BANDPLAN**

## Footnotes

- Preferred in those CEPT countries having implemented **ECA35**
- Between 77.5 and 78 GHz the amateur and amateur satellite service have a primary/exclusive status and between 75,5-76 GHz a primary status through ECA footnote ECA35 in CEPT countries, while the status is secondary in the remainder of the allocation. The all mode section in the secondary segment should only be used in case the preferred segment cannot be used
- Preferred in those countries not having implemented **ECA35**

**1.14 122.250 – 123.000 GHz Bandplan**

Frequency	Maximum Bandwidth	Mode	Usage
122.250	2700 Hz	All Mode	NARROW BAND MODES
122.251			
122.251		All Mode	
123.000			

**1.15 134.000 – 141.000 GHz Bandplan**

Frequency	Maximum Bandwidth	Mode	Usage
134.000		ALL MODES	AMATEUR SATELLITE SERVICE
134.928 134.928	2700Hz	ALL MODES	134.930 GHz Narrow band center of activity
134.930 134.930		ALL MODES	
136.000 136.000		ALL MODES	(not preferred) (a)
141.000			

**1.15.1 Notes: BANDPLAN**

## Footnotes

- a) Between 134 and 136 GHz the amateur and amateur satellite service have a primary/exclusive status, while the status is secondary in the remainder of the allocation. The all mode section in the secondary segment should only be used in case the preferred segment cannot be used

**1.16 241.000 – 250.000 GHz Bandplan**

Frequency	Maximum Bandwidth	Mode	Usage
241.000		ALL MODES	(not preferred) (a)
248.000		ALL MODES	AMATEUR SATELLITE SERVICE & NARROW BAND MODES
248.001		ALL MODES	(Preferred segment) (b)
250.000			

**1.16.1 Notes: BANDPLAN**

## Footnotes

- a. The all mode section in the secondary segment should only be used in case the preferred segment cannot be used
- b. Between 248 and 250 GHz the amateur and amateur satellite service have a primary/exclusive status, while the status is secondary in the remainder of the allocation

## 1.17 Additional Band plans

These band plans are only in use in some countries who have access to those frequencies. They can serve as an example for future use in other countries of Region 1.

### 1.17.1 Table 1 Irish 40–44 MHz (8 metre) Band Plan for Amateur Service

Frequency	Maximum Bandwidth	Mode (a)	Usage
40.000 40.100	1000 Hz	Telegraphy MGM	Lower Beacon Band 40.013 (Ireland) planned 40.071 (Denmark) and 40.050 (UK) operational.
40.100 40.200	500 Hz	Telegraphy	40.150 CW centre of activity and CW calling frequency. 40.190 – 40.200 future intercontinental CW DX sub-band
40.200 40.300	2700 Hz	Telegraphy SSB	40.200 future CW and SSB intercontinental DX calling frequency 40.200 – 40.230 future intercontinental SSB DX sub-band 40.250 SSB centre of activity and SSB calling frequency. 40.285 SSB cross-band centre of activity
40.300 40.400	2700 Hz	MGM Narrowband Telegraphy	40.305 PSK Centre of activity 40.310 -40.320 future EME centre of activity 40.320 -40.380 MS centre of activity
40.400 40.660	20 kHz	All Modes	40.410 SSTV 40.440 -40.480 Simplex FM Internet Voice Gateways 40.490-40.510 NOT TO BE USED 40.520-40.650 Digital Communications 40.600 DV calling Note: Avoid 40.49-40.51 (3 <sup>rd</sup> harmonic falls close to 121.5 the aeronautical distress frequency)
40.660 40.680	1000 Hz	Telegraphy MGM	Upper Beacon Band (Subject to change) 40.661 – 40.674 Slovenia 40.675 – 40.679 South Africa Applicable for countries where Amateur Service allocation is limited to all or part of the ISM band 40.66 – 40.70 MHz
40.680 40.700	2700 Hz	Telegraphy MGM SSB	SSB frequencies 40.681, 40.684, 40.687, 40.690, 40.693, 40.696 SSB calling frequency 40.681 MHz (Subject to change) Applicable for countries where Amateur Service is limited to all or parts of the ISM band 40.66 – 40.70 MHz
40.700 43.000 43.000	20 kHz	All Modes	40.710-40.890 FM/DV Repeater Inputs, 20 kHz spacing 1.1 MHz I/P-O/P 41.210 -41.390 FM/DV Repeater Inputs, 20 kHz spacing (paired with 56.810 – 56.990 15.6 MHz I/P-O/P) 41.410 -41.590 FM/DV Simplex 41.500 FM calling frequency 41.810 – 41.990 FM Repeater Outputs, 20 kHz spacing (paired with 40.710-40.890 1.1 MHz I/P-O/P spacing) 42.000-43.000 simplex 12.5 kHz spacing 42.500 FM calling frequency (12.5 kHz channel)
43.000 45.000	500 KHz	All modes	Could be paired with 52 – 54 MHz and/or 54-56 MHz (subject to the outcome of WRC-19 and/or the CEPT ECA)

**1.17.2 Table 2 Irish 54.0–69.9 MHz (5 metre) Band Plan for Amateur Service**

Frequency	Maximum Bandwidth	Mode (a)	Usage
54.000 56.000	500 kHz	All modes	Could be paired with 43-45 MHz Note: R2 BC NTSC video carrier 55.25 MHz
56.000 58.000	20 kHz	All Modes	56.010 – 56.090 1.8 MHz I/P-O/P FM/DV repeaters input channels, (20 kHz spacing paired with 57.810-57.890) 56.100 – 56.800 Digital communications 56.810 – 56.990 15.6 MHz I/P-O/P FM/DV repeaters output channels, (20 kHz spacing paired with 41.210-41.390) 57.810 – 57.990 1.8 MHz I/P-O/P FM/DV repeaters output channels, (20 kHz spacing paired with 56.010-56.090)
58.000 59.500	20kHz	All Modes	58.000 – 58.475 FM/DV Simplex 58.500 FM calling frequency 58.540 – 58.580 Simplex FM Internet Voice Gateways 58.610 SSTV 58.620-58.750 Digital communications 58.630 DV calling  Note: R2 BC NTSC colorburst 58.30 MHz
59.500 59.600	2700 Hz	MGM Narrowband Telegraphy	59.505 PSK Centre of activity  59.510 – 59.520 EME centre of activity 59.520 – 59.580 MS centre of activity
59.600 59.700	2700 Hz	SSB Telegraphy	General Use 59.685 for cross band
59.700 59.800	2700 Hz	SSB Telegraphy	59.710 -59.750 International SSB DX window 59.710 International SSB calling and centre of activity 59.750 SSB National calling and centre of activity
59.800 59.900	500 Hz	Telegraphy exclusive	59.850 CW National calling and centre of activity 59.870-59.890 International CW DX window 59.890 CW International calling and centre of activity
59.900 60.100	1000 Hz	MGM Telegraphy	Beacon Band  60.050 (UK) operational 60.013 (Ireland) planned
60.100 69.900	8 MHz	Experimental Broadband	Centre Frequency 65.00

## 2 MANAGING FREQUENCY ALLOCATIONS & BAND PLANNING

### 2.1 Introduction to VHF/UHF/ $\mu$ Waves bands and bandplans

#### 2.1.1 Amateur and Amateur Satellite Service frequency allocations above 30 MHz

Current frequency allocations to the Amateur Service and the Amateur Satellite Service from 30 MHz upwards, as established at the WARC 1979 and maintained at the WARC 1991 (Torremolinos), 2000 (Istanbul) and 2003 (Geneva), are set out in section 2.2., which also gives some other useful information extracted from the ITU Radio Regulations.

ITU Regulations strongly recommend that Radio Services use their frequency allocations rationally and economically. With an eye to the retention of the frequencies allocated to the Amateur Service and the Amateur Satellite Service it follows that full use should be made of all amateur bands, including the shared bands (Recommendation adopted at the IARU Region I Conference in Stresa, 1956).

Particularly the use of the UHF/Microwaves bands should be encouraged by stressing UHF and Microwaves technique in amateur magazines and by organising contests, meetings, conferences etc. especially aimed at stimulating UHF and Microwaves activity (Recommendation adopted at the IARU Conference in Brussels, 1969).

### 2.2 IARU-R1 Bandplanning: principles

At the meeting of the IARU Region 1 VHF/UHF/Microwaves Committee at Düsseldorf, April 1989, the following principles of bandplanning were adopted. In the same month these principles were accepted as (interim) Region 1 policy by the Executive Committee of IARU Region 1. They were definitely adopted at the IARU Region 1 Conference in Torremolinos, 1 - 6 April 1990.

#### 2.2.1 Basis

Many of the transmission modes and techniques currently used in the Amateur Service, such as ATV, RTTY, FAX, repeaters, satellites etc. are not or not fully compatible. To make orderly communication on and efficient use of the amateur bands possible, bandplanning is mandatory.

The basic philosophy behind bandplanning should be:

- *to assign frequencies for certain activities in such a way that all current users can practice the various modes of amateur radio with a minimum of mutual interference, provided they are using state-of-the-art equipment and communication techniques.*

Possibilities for shifts and/or extensions in the plan, which undoubtedly will become necessary in view of future developments in techniques and communication modes should be carefully considered before adopting a bandplan.

- *to avoid, through careful planning, the necessity of drastic changes in future, as this type of changes could lead to technical difficulties and/or large expenses for many amateurs (for instance, a complete change in repeater channel frequencies).*
- *With good anticipation only gradual changes, adaptations and additions should be required in the course of time.*

All bandplanning should be in accordance with the I.T.U definitions of the Amateur Service and the Amateur Satellite Service as found in the I.T.U. Radio Regulations:

- **S1.56** *Amateur Service: A radiocommunication service for the purpose of self-training, intercommunication and technical investigations carried out by amateurs, that is, by duly authorized persons interested in radio technique solely with a personal aim and without pecuniary interest.*
- **S1.57** *Amateur Satellite Service: A radiocommunication service using space stations on earth satellites for the same purposes as those of the Amateur Service*

In accordance with the IARU principle of using Primary and Primary Exclusive allocations in preference to secondary allocations, it is recommended that Amateur and Amateur Satellite weak-signal operation should, wherever possible, use the 500 MHz segment 75.5 GHz to 76.0 GHz as per CEPT Footnote **ECA35** in the European Frequency Tables. Region 1 societies in CEPT countries should encourage their administrations to implement **ECA35** as soon as possible. The IARU bandplan should be amended accordingly. (Davos 2005)

In the bands above 76 GHz, for example 241 GHz, users are encouraged to use the Primary Exclusive (Davos 2005)

### 2.2.2 Remarks on the practical implementation

- ***The definition of the Amateur Service implies that bandplanning should take into account all aspects of amateur radio – self-training, intercommunication and technical investigations.***
  - Consequently, for any band the bandplan should aim to accommodate for the maximum number of amateur activities (modes, techniques), both now and in the future.
  - Clearly there are impossible situations: CCIR ATV cannot be carried out in the 144 MHz allocation etc.
  - No band should, however, be allocated mainly to one aspect of amateur radio.
  - When, due to its nature, an activity cannot be incorporated within the bandplan of a specific band, it should not be forgotten that we have many bands available above 30 MHz. The more activity we can generate on the higher bands the better for the defense of these bands against the claims of other services!
- ***Technical investigations by amateurs, be it in the classical field of propagation research or on modern digital communication techniques etc. are a laudable and legitimate aspect of amateur activity.***
  - However, when using amateur bands for experimenting with communication techniques, the transmitting techniques, the equipment and the frequencies used should never be taken as the closing entry in the chain of development. Within a bandplan the use of optimum bandwidths, transmitting equipment and techniques should be the normal aim for any amateur.
  - Any required standardisation should also be aimed at the optimum use of amateur frequencies, and be flexible enough to accommodate future improvements.
- ***In view of the large number of (potential) amateur users who will only practice communication, the allocation of part of an amateur band to channelized work, be it FM repeaters or FM simplex, Packet Radio, etc. can often be considered as practically final. Care should be exercised to ensure that other aspects of amateur radio will find sufficient room and that room is available for future developments in the Amateur Service.***
  - Techniques used in channelized amateur work should also be state-of-the art. For instance, accommodating more channels should, where possible, be sought within the existing allocation by using more modern techniques, smaller bandwidths etc. Other Radio Services have done this. In the spirit of the definition of the Amateur Service there should be progress in techniques, not just a claim for more spectrum, sticking to old techniques!
- ***FM repeaters provide a communication service to mobile amateur-stations (including hand-held equipment). In some cases they may be installed to aid the accessibility of stations in mountainous areas.***
  - They are not intended to make DX contacts possible, and hence their coverage under normal propagation conditions should be limited.
  - The number of repeater stations installed should be determined by the required regional coverage the expected number of intended users
  - FM repeaters should not regularly be used as local chat channels for fixed (home) stations. This interferes with their defined use.



### 2.2.3 Coordination process:

Repeater frequency allocations in neighbouring countries within Region-1 should be coordinated in case their coverage pattern would overlap the border.

- Coordination with the national society first.
- For cross-border disputes to co-ordinate with the neighbouring societies relevant coordinators.
- In the event of escalating to the national regulator that all the affected societies to be informed. This should only be the last resort if steps one and two fail.

The primary purpose of beacons is the checking of propagation conditions, both for every day amateur use and for special propagation research projects. When allocating exclusive segments of a band to beacons regard should be given to:

- Reasonable frequency separation is needed to allow for, for instance, auroral spread;
- Guard bands at the edges of the segment are desirable to prevent de-sensitization of receivers used for beacon projects due to strong local traffic on adjacent frequencies.

### 2.2.4 Some definitions

At the IARU Region 1 Conference 1996 (Tel Aviv) it appeared useful when amending bandplans to use the following definitions:

- **An unmanned station** is a station in the Amateur (Satellite) Service which transmits while the license holder of the station is not present.
- **A network station** is a station in the Amateur Service which has a permanent link to one or more network stations.

## 2.3 ITU and WRC Frequency Allocations Process

The top-level allocations for all radio services are determined by the ITU Radio Regulations. This includes the amateur service and amateur satellite service. Following the 2012 World Radio Conference (WRC-12), a copy can be found on the ITU website ([www.itu.int](http://www.itu.int)) at:-  
<http://www.itu.int/pub/R-REG-RR-2012>

A WRC is held approximately every four years. Any changes to an allocation must be agreed by the administrations of ~190 countries, many of which are grouped into Regional Telecommunications Organisations (RTOs) as per the list below. IARU has only observer status at ITU. The WRC process involves lengthy studies for each agenda item and numerous meetings at national and regional level in the years leading up to a WRC. Each WRC also agrees the agenda items for the next WRC.

In order to defend existing amateur allocations or acquire new ones, Societies must wherever possible engage with the spectrum managers in their National Regulatory Authority. In addition they need to build working relationships with persons in other concerned organisations, where frequency bands are shared with another primary and/or secondary user(s).

CEPT is an example of a RTO and is an association of 48 countries. This makes CEPT the largest RTO and is an influential block of votes at ITU. Proposals for any current or future agenda items at WRC require CEPT administrations to agree a European Common Proposal well in advance of a WRC. A result of the increasing influence of RTOs and other regional bodies is that amateur matters require the early and ongoing support of Societies to engage with their administrations (either in CEPT, or others such as the African or Arab spectrum groups).

For example, at the 2014 Varna General Conference, an early IARU Region-1 proposal to CEPT for a future WRC-18 agenda item for harmonised allocations at 1.8, 50 and 3400 MHz was discussed. It was recommended that it be strongly supported by Member Societies, who in turn would need to engage with their administrations. If successful this would be discussed and agreed as a future agenda item at WRC-15 (along with 5MHz and other agenda items that affect amateur radio).

The Varna Conference and the IARU-AC also noted how the earlier start to the future-WRC preparation process had changed in recent years, along with the growing pressures on amateur spectrum, and that this would feed into Spectrum Strategy.

### 2.3.1 List of Regional Telecommunications Organisations (RTOs)

Region-1: Europe, Africa, Middle East, North Asia

- CEPT - European Conference of Postal and Telecommunications Administrations
- ATU - African Telecommunications Union
- ASMG - Arab Spectrum Management Group
- RCC - Regional Commonwealth in the field of communications (Russia et al)

Region-2: Americas

- CITEL - Inter-American Telecommunication Commission

Region-3: Asia-Pacific

- APT - Asia Pacific Telecommunity
- Channel designation system for VHF/UHF FM channels

## 2.4 Channel designation system for VHF/UHF FM channels

Although the FM channels can be referenced by their centre frequency, a numbering/naming system for FM channels in the 50 MHz, 145 MHz and 435 MHz is recommended (Tel Aviv 1996)

Note: For the microwave bands the "old" numbering system as indicated in the bandplan still is recommended.

### 2.4.1 Principle

The system is based upon the following principles:

- *For each band, there should be a "designator letter":*
  1. 50 MHz : **F**
  2. 145 MHz : **V**
  3. 435 MHz : **U**
- *Each designator letter should be followed by two (for 50 and 145 MHz) or three (for 435 MHz) digits which indicate the channel.*
- *If a channel is used as a repeater output, its designator should be preceded by the letter "R".*
- *In the 50 MHz band the channel numbers start at F00 for 51.000 MHz and increment by one for each 10 kHz.*
- *In the 145 MHz band the channel numbers start at V00 for 145.000 MHz and increment by one for each 12.5 kHz.*
- *In the 435 MHz band the channel numbers start at U000 for 430 MHz and increment by one for each 12.5 kHz.*

### 2.4.2 Examples

F51	Simplex frequency 51.510 MHz
RF79	Repeater with output frequency 51.790 MHz
V40	Simplex frequency 145.500 MHz (the old S20)
RV48	Repeater with output frequency 145.600 MHz (the old R0)
U280	Simplex frequency 433.500 MHz (the old SU20)
RU002	Repeater with output frequency 430.025 MHz (the old FRU1)
RU242	Repeater with output frequency 433.025 MHz (the old RB1)
RU368	Repeater with output frequency 434.600 MHz (the old RU0)
RU692	Repeater with output frequency 438.650 MHz (the old R70) $\mu$

### 2.4.3 Notes:

- *In the 50 MHz band no FM channels are defined below 51 MHz. (See also footnote e to the 50 MHz bandplan.*
- *In the 145 MHz band FM channels only exist for the segment with the channel frequencies 145.000 -- 145.800 MHz (the latter channel may be used for a downlink by manned space stations)*
- *In the 435 MHz band no FM channels are defined in the segment 432.000 MHz - 433.000 MHz*



# **PART 3**

## **CONTESTING**

# 1 RULES IARU R1 50/70 MHZ, 145 MHZ AND UHF/ $\mu$ W CONTESTS

New rules for 2018

## 1.1 Objective

The main objectives are to make as many contacts as possible and to have fun. Other objectives may include improving your operating skills, testing new equipment configurations and techniques, expanding your horizons by operating on the microwave bands and exploring radio propagation.

## 1.2 Definitions

- **Station:** set of antennas, transmitters and receivers used during the contest on each frequency band (i.e. multiband setups are composed of multiple stations).
- **Location:** geographical area with diameter of no more than 500 meters where the station resides during the contest.
- **Call Sign:** identification of the station during the contest. Added prefix and/or suffix do not generate different call sign (i.e. S50AAA/p or DL/S50AAA are the same call sign as S50AAA).
- **Operator:** an individual that operates the station during the contest using the station's call sign. Operator may reside inside (local operator) or outside (remote operator) the location. During the contest an operator may operate only stations that form one entry.
- **Entries:**
  - **MULTI operator:** stations from the same location, operated by more than one operator and using one callsign on all bands.
  - **SINGLE operator:** stations from the same location, operated by the same operator and using one callsign on all bands, with no operational assistance of another person during the contest.
  - **6 HOURS:** stations from the same location, operated by any number of operators and operating according to the 6 hours' time rule. The 6 hour time segment can be divided into maximum two periods. The time of the first QSO sets the start time of the first period. When operating in two periods, the pause between the periods must be longer than 2 hours. The first time difference of 2 hours or more between two consecutive QSOs marks the pause segment. Only the QSOs that fall into the combined 6 hour time segment will be counted for points. Participants are welcome to operate longer than 6 hours and in such case they shall send their complete log (the contest robot will automatically extract the 6 hours part from the log, while the rest of the log entries will be used for cross-checking purposes).
  - **LOW POWER:** multi or single operator entries, transmitting with total of up to 100 W PEP from the transmitter and using only one directional or omnidirectional antenna system. The same antenna must be used for transmit and receive. Directional antenna system is a single directional antenna or a group (array) of single directional antennas, grouped together to achieve maximum obtainable gain in a given direction (that is, all the antennas in the group shall be pointed in the same direction). Omnidirectional antenna is an antenna with a radiation pattern that has approximately the same gain in all azimuth directions.

## 1.3 Conditions for entrants

All licensed radio amateurs in Region 1 may participate in the contest.

The entrants must operate within the letter and spirit of the contest. Entrants must operate according to the license conditions of the country where the station resides. Stations operating under special high power license can only entry as check logs.

## 1.4 Date of contests

- The 50/70 MHz contest will begin on the third Saturday of June.
- The 145 MHz contest will start on the first Saturday of September.
- The UHF/Microwaves contest will start on the first Saturday of October.
- The contest will commence at 1400 hours UTC on the Saturday and end at 1400 hours UTC on the Sunday.

## 1.5 Contest sections

### 1.5.1 50/70 MHz Contest:

The contests shall comprise the following sections for:

- **50 MHz band:**
  - **SINGLE (SO):** single operator entries.
  - **MULTI (MO):** multi operator entries.
  - **6HOURS (6H):** 6 hours entries.
- **70 MHz band:**
  - **SINGLE (SO):** single operator entries.
  - **MULTI (MO):** multi operator entries.

### 1.5.2 145 MHz contest:

- **SINGLE (SO):** single operator entries.
- **MULTI (MO):** multi operator entries.
- **SINGLE LOW POWER (SO-LP):** single operator low power entries.
- **MULTI LOW POWER (MO-LP):** multi operator low power entries.
- **6HOURS (6H):** 6 hours entries.

### 1.5.3 UHF/Microwaves Contest:

The contests shall comprise the following sections for:

- **435 MHz band:**
  - **SINGLE (SO):** single operator entries.
  - **MULTI (MO):** multi operator entries.
  - **SINGLE LOW POWER (SO-LP):** single operator low power entries.
  - **MULTI LOW POWER (MO-LP):** multi operator low power entries.
  - **6HOURS (6H):** 6 hours entries.
- **1.3 GHz, 2.4 GHz, 3.4 GHz, 5.7 GHz, 10 GHz bands and for the Millimetre group (the combined group of amateur bands above 10 GHz):**
  - **SINGLE (SO):** single operator entries.
  - **MULTI (MO):** multi operator entries.

## 1.6 Operating

Only one signal on the band is allowed at any time.

Station must operate from the same location throughout the contest time.

## 1.7 Contacts

Each station may only be worked once per band. If a station is worked again on the same band, only one contact may count for points. Any duplicate contacts should be logged without claim for points and clearly marked as duplicates.

Contacts made via active repeaters and EME contacts do not count for points.

## IARU-R1

Competitors are obliged to follow the common definition for a valid QSO (as defined in the VHF Managers Handbook and replicated below). The contest exchange (call, report, QSO number and locator) shall be sent and confirmed on the band where the contact started and only during the contact.

No attempt should be made during the QSO to obtain any part of the required exchange information via other communication methods such as the Internet chat channel, DX Cluster, talk-back on another amateur band, telephone etc.. Such a secondary method invalidates the contest QSO.

Self-spotting is permitted on all media except the DX Cluster (sending lots of self-spots to chat rooms is not recommended and is discouraged).

### 1.7.1 Acceptable examples when using a secondary method:

- "Shall we make a sked on 144.388?"
- "I have QRM, let's move to 144.218 kHz and start again"
- "Nothing received, please try again" and the QSO starts again
- "Thank you for a nice QSO" - Note: Only after the QSO has completed on the radio!

### 1.7.2 Unacceptable examples when using a secondary method:

- "I need your serial number"
- "Please repeat all information"
- "Please confirm <report>, <serial number>, <locator> etc."

### 1.7.3 Definition for a valid contest QSO:

A valid contact is one where both operators during the contact have:

- mutually identified each other
- received a contest exchange, and
- received a confirmation of the successful identification and the reception of the contest exchange.

## 1.8 Type of emission

Contacts may be made in **A1A**(CW), **J3E**(SSB) or **F3E**(FM) (**G3E**(PM)).

**MGM** (Machine Generated Mode) modes are allowed during the 50/70 MHz contest. Every MGM contact shall be properly marked in the LOG with EDI mode **code 7**.

## 1.9 Contest exchanges

Code numbers exchanged during each contact shall consist of the RS, RST or RSQ (MGM mode) report, followed by a serial number commencing with 001 for the first contact on each band and increasing by one for each successive contact on that band. This exchange must immediately be followed by the complete locator of the sending station (examples: 59003 JO20DB or 579123 IN55CC).

All times must be logged in UTC.

Call signs logged must be the same as those exchanged over the air by the entrants during the QSO.

For contacts on 50 MHz, outside of Region 1, the received locator can be 4 digits and "MM" will be added as 5th and 6th digit.

Correction of logged exchanges after the contest, by use of any database, recordings, email or other method, is not allowed.

## 1.10 Scoring

For the amateur bands up to 10 GHz inclusive, points will be scored on the basis of one point per kilometre, i.e. the calculated distance in kilometres will be truncated to an integer value and 1 km will be added. The centre of each locator square is used for distance calculations. In order to make contest scores comparable, for the conversion from degrees to kilometres a factor of 111.2 should be used when calculating distances with the aid of the spherical geometry equation.

All QSOs including those with unique stations shall count for points (unique station is a station that appears in the log of only one contest entrant).

For the combined higher bands (Millimetre group) the score will be the sum of the points scored on each of the bands, using the following multiplication factors for the number of kilometres scored on each band:

- 24 GHz 1 x
- 47 GHz 2 x
- 76 GHz 3 x
- 122 GHz 4 x
- 134 GHz 8 x
- 245 GHz 10 x

## 1.11 Entries

The entries must be set out in EDI digital/electronic form (refer to VHF Managers Handbook, Part 3 section 5) separately for each frequency band. EDI header shall as a minimum contain the following fields:

- Callsign and WWL used (PCall and PWWLo)
- Section and band (PSect and PBand)
- Operators callsigns (RCall for SO entries, RCall and Mope1, Mope2,... for MO entries)
- E-mail address (RHBBS)
- TX power in watts (SPowe)
- Antenna (SAnte); it shall be clearly identifiable how many antenna systems were in use

Logs shall be sent no later than the second Monday following the contest weekend. Late entries will be accepted as check logs.

By submitting the contest or check log, an entrant agrees that he / she has:

- understood the contest rules and agrees to be bound by them,
- operated according to all the rules and regulations that pertain to his and/or station license,
- agreed the cross-checked log may be made open to the public, except for the personal data in PAdr1, PAdr2, RName, RAdr1, RAdr2, RPoCo, RCity, RCoun, RPhon and RHBBS lines of EDI file format,
- agrees the contest organizer can score, amend, publish, republish, print, and otherwise distribute (by any means including paper or electronic) the entry either in its original format, in any other suitable format with or without modifications or combined with the entries from other contestants for entry into the specific contest, other contests, or for other reasons including training, development and advancement of amateur radio,
- accepts all decisions of the contest organizer as final.



## 1.12 Judging of entries

All logs are checked using custom software and human judgement.

The claimed contact shall be disqualified for any error in the information logged by the entrant. When there is high evidence that the error is due to the wrongly logged information of the transmitting station (i.e. wrong date/time or call/UL) such a LOG shall not be used for adjudication purposes. The final judging of the entries shall be the responsibility of the contest organizer whose decision shall be final.

Entrants deliberately contravening any of these rules, attempting fraud or flagrantly disregarding the IARU Region 1 band plans shall be disqualified. Each VHF Manager and/or national Contest Committee can propose to the contest organizer disqualification or penalization of an entrant.

## 1.13 Awards

### 1.13.1 Section winners:

Certificates will be issued by the contest organizer to the winners of the sections on each band up to 10 GHz and for the Millimetre group.

### 1.13.2 Overall winners for UHF/Microwave contest:

The overall winner of the IARU Region 1 UHF/Microwaves contest will be declared separately for the SO and MO sections.

For the overall results tables, the scores of the entrants operating on at least two of the following bands will be combined, using an adaptive multiplier system:

### 1.13.3 Millimetre group

Note: SO entries to the 6H section on 435 MHz will be included in the Overall SO classification if the entries on all bands are SO. MO entries to the 6H section on 435MHz will be included in the Overall MO classification.

The band multipliers for the overall score are calculated as follows:

- The multiplier for 435 MHz is one.
- The multiplier for each of the other bands is equal to the winning score on the 435 MHz band divided by the winning score on each band. The multiplier on each band for the SO and MO sections are determined separately.
- Example:
  - Winning score in SO on 435MHz is 200,000 points
  - Winning score in SO on 1.3GHz is 20,000 points
  - The multiplier for SO on 1.3GHz is 200,000 divided by 20,000 = 10
  - So, all scores in SO on 1.3GHz are multiplied by 10 for the Overall SO results table
- The overall millimetre group scores are calculated according to rule 9 before the multiplier for the millimetre group is calculated.

## 2 RULES IARU REGION I ATV CONTEST

### 2.1 Goal

Stimulation of ATV activity by organizing a yearly international ATV contest.

### 2.2 Terms and Definitions

**ATV contest:** Competition of licensed or receive-only ATV stations in a certain period of time, on each UHF/Microwave band on which ATV transmissions are allowed, using the mode(s) authorised for that band. The distance between stations that make contacts on several bands define the number of earned points.

**Repeater:** A public (amateur) service that (re)transmits received signals that are intended to be received by more than one person.

**Station:** Any person (or group of persons using one call sign) within IARU Region 1 that is able to transmit and/or receive Amateur Television signals from their own location or remotely, without being a repeater. No more than one transmitter may be in use at the same time.

**Rover station:** Any station that is not fixed to one location that moves at least a minimum of five kilometres. Every time location is changed the moving station should be considered as a new station with the same call sign. For that reason a new log sheet and four digit code should be used by the moving station.

**Four digit code:** Four random chosen digits. The digits shall neither be the same (e.g. 2222) nor consecutive (e.g. 4567 or 5432).

**Contact:** Contacts are considered to be valid when a four digit code that is transmitted by another ATV station is received. Contacts made via repeaters or transponders are not considered as a contact.

**IARU locator:** The six, eight or ten digits of the Maidenhead locator which is related to the longitude and latitude coordinates of the actual position of the antennae that are used during the contact.

**Vision report:** The internationally recognized codes P0 to P5:

	Analogue	Digital
P0	No picture received	No picture received
P1	Synchronisation with little picture content	Only occasional blocks visible
P2	Only large images (call sign etc.) perceivable	Sufficient blocks to read call signs
P3	Picture noisy but some detail resolved	Some blocking
P4	Picture slightly noisy, but with good detail and resolution	Occasional blocking
P5	Noise-free picture	Solid picture

**Log sheet:** A log sheet has a format not smaller than A4, containing all information that is needed to judge the contacts made and claimed points. It consists of a standard cover sheet and data sheets for every individual band

- A standard cover sheet contains the essential information required to judge the contest entry. The following information shall be submitted:
  - name and address of the (first) operator,
  - station call sign,

## IARU-R1

- IARU locator,
- bands used, with the transmitted four-digit code group used for each band,
- claimed score for each band.

The coversheet should show the signature of the (first) operator certifying the correctness of the log(s) submitted. In case of digital delivery of the log, typed name is the alternative of the signature.

- Data sheets for every individual band containing the following columns in the order named:
  - date,
  - time in UTC,
  - call sign of the station worked/seen,
  - report sent: P# report followed by serial number,
  - report received: P# report followed by serial number,
  - (seen) four digit code,
  - IARU locator received,
  - number of points claimed.

It is strongly recommended to use the Excel sheet that is developed especially for this purpose (see Appendix 3B).

### 2.3 Responsibilities

**Contestants:** Operate within the letter and spirit of the contest and in accordance with their licences of their country. Stations operating under special high power licenses shall do so "hors concours". Completion and delivery of the entry

**National ATV manager, VHF manager or the National Contest Committee:** Judge logs in time, send the results within four weeks after the contest to the IARU ATV manager.

**IARU ATV contest manager:** Organize, judge logs in time, issue results within six weeks after the contest.

### 2.4 Contest

**Date of contest:** The contest will be held in the second full weekend of June.

**Duration of the contest:** The contest will commence at 12:00 UTC on the Saturday and will end at 18:00 UTC on the Sunday. It is recommended that the national societies will run their ATV contests at the same time as the IARU Region 1 ATV contest takes place.

**Contacts:** For contest scoring purposes a participating station may be worked or viewed only once on each band. A roving station is considered as a new station, every time it has changed its location.

**Contest exchanges:** The following information shall be exchanged during a contact:

- Four digit code. For each band used, a transmitting station shall transmit the four digit code that shall not change throughout the contest. For roving stations that changed location: both transmissions should be verified by a new four digit code. For new contacts with stations that were logged before; the roving station should request the involved stations to transmit a new four digit code and mention those digits as remarks in their log sheet.
- THIS FOUR DIGIT CODE SHALL BE EXCHANGED IN VIDEO ONLY AND SHALL NOT BE TRANSMITTED BY ANY OTHER MODE THAN VISION.
- Call sign
- Vision report,
- IARU locator (the location of the receiving or transmitting antennae does define the location of the station),
- Contact serial number, starting with 001 on each band used and increasing by one for each successive contact on that band, starting from one for the new log sheet in use by roving stations).

## IARU-R1

**Scoring.** A two-way exchange of the four-digit code group by vision together with the exchange of the other information shall score:

- for contacts on the 435 MHz band: 2 points/kilometre
- for contacts on the 1.3 GHz band: 4 points/kilometre
- for contacts on higher bands: 10 points/kilometre

If only one station received the four-digit code group, and the other information was exchanged, the scores for both stations shall be reduced by 50%.

Note: for scoring purposes all valid contacts shall be deemed to have taken place over a distance of at least 5 kilometres, even if the two stations in contact have the same or adjacent IARU locators.

**Entries:** The entries must be set out on completed log sheets. A copy of the logs shall be sent to the national ATV Manager, VHF Manager or the national Contest Committee, not later than the third Monday following the contest weekend. The submission of the logs implies that the entrant accepts these contest rules. The logs will be sent at [IARU ATV@uba.be](mailto:IARU_ATV@uba.be), they will be forwarded to the organizing society

**Judging of entries:** The judging of the entries shall be the responsibility of the organizing society, whose decision shall be final. Entrants deliberately contravening any of these rules or flagrantly disregarding the IARU Region 1 band plans shall be disqualified. Minor errors may result in loss of points. The claimed contact will be disqualified for an obviously wrongly stated locator, call sign, code number or a time error of more than 10 minutes.

**Awards:** The winner on each band and the overall leading station shall receive a certificate. The organizing society may also send certificates to all entrants if they wish so.

### 3 PROCEDURE FOR ORGANISING IARU-R1 1 VHF/UHF/ $\mu$ WAVE CONTESTS

The organisation of the IARU contests have been changed during the IARU General conference in Landshut(2017).

It is proposed to create a team of experienced VHF contesters and contest robot owners/de-signers to define common checking rules for automatic contest adjudication applications.

#### 3.1 Terms of reference for the contest working group

##### 3.1.1 Objectives

- Organisation and conduct of IARU-Region 1 VHF/UHF/SHF contests including:
  - Collecting logs
  - Evaluating and judging of the received logs
- Publication of official results in a timely manner
- Preparation of awards and certificates
- Encouragement of new participants, modes, activity and use of the higher frequency bands
- Promotion of IARU-Region 1 VHF/UHF/SHF to encourage participation - by website and other means such as social media

##### 3.1.2 Responsibilities

- To engage contesters both electronically and at major events such as Friedrichshafen where an annual forum and awards ceremony might occur
- To maintain and modify contest rules as appropriate
- To further develop contest organisation
- To decide when and how the changes to the contest rules and contest organisation would be implemented
- To maintain an appropriate 'Contesting Handbook' that would be the master refer-ence for the Organisation and Rules of IARU Region-1 VHF/UHF/SHF Contests - including any directly associated procedures and items such as log file formats
- To arrange for contest information, rules and results to be easily found online
- To coordinate the development of the contest robot
- Annual budgeting and expenditure, in cooperation with the C5 Chairman. This budget needs to be approved by the EC.
- To provide a yearly report to EC
- To provide reports to C5 meetings
- To operate in an open and transparent way including:
  - Regular consultation of contest managers and contesters
  - Ensure that there is at least 6 months' notice period before any agreed contest rule changes are implemented
  - In case of serious problems, appeals (or strategic issues), C5/EC would continue to be the arbiter

##### 3.1.3 Group Membership

The Working Group consists of:

- C5 Contest Co-Ordinator
- C5 Chair
- up to seven additional ordinary members
- Members shall be active contesters. Of the ordinary members, at least one needs to be:
  - Robot/IT expert
  - VHF/UHF specialist
  - Microwave specialist

IARU-R1

#### **3.1.4 Actual membership**

- C5 Contest Co-Ordinator : IK3KKW
- C5 Chair: ON4AVJ
- Members: OE1MCU, OK1VAO, F5LEN, OZ5TG, S53WW, OM3BH, HA0LC

#### **3.2 Financing the contest robot**

DL3MBG on behalf of DARC and OE1MCU on behalf of ÖVSV are taking over the responsibility and financing for the Contest-Robot in line with the VHF-Handbook and the CWG under the guidance of C5. This Contest-Robot will be shared with all Member Societies when the Contest-Robot has accomplished an appropriate maturity.

#### **3.3 Sub-regional VHF/UHF/ $\mu$ Wave contest coordination within IARU-R1**

It is recommended that the national and sub-regional activity contests rules should be complementary and that those contests should be open to all (National and International contesters) to encourage and promote activity on the VHF, UHF and SHF bands.

In order to avoid confusion and improve efficiency, the submission of contest entries shall be no later than the second Monday after the contest, which is in accordance with the rules approved by IARU Region 1. (Varna 2014)

## 4 MGM CONTEST OPERATING PROCEDURES

### 4.1 Introduction

MGM is now a mainstream mode alongside SSB and CW for the exchange of contest information, facilitated by the widespread and low cost availability of PCs and free software.

- The main purpose of this guide is to provide a protocol for the efficient exchange of contest information when using MGM. However, you will not be penalised for using a different protocol so long as the complete contest exchange only takes place over the air.
- The protocol is an extension of standard meteor scatter procedures to include contest information, and the description is based around the standard WSJT-10 messages and modes (the most commonly used in contests), although the same messages may be used with other Machine Generated Modes such as PSK which are not included in the WSJT suite.
- This Guide does not describe the interconnections between PC and transceiver, since such information is readily available on the internet. All that is required is PTT control via the PC and line in/out connections for transmit and receive audio.
- This Guide does not describe how to set up or optimise the use of MGM software, nor does it compare the merits of different software applications.

### 4.2 What needs to be logged?

In VHF contests the following needs to be received over the air and logged accurately by both parties to a contest exchange:

- both calls
- report
- serial number
- locator

### 4.3 Contest Exchange

#### 4.3.1 Standard Exchange

such as attempting a QSO on a frequency agreed via a chat room such as ON4KST.

As an example, suppose GM4VVX set up a QSO with G8BCG on ON4KST as follows (in practice, this is all much simpler than when written down, and experienced operators will know from the contents of the text box above what to send):

GM4VVX would

- Enter G8BCG's call in his log
- Set up the text box as shown, and send message Tx1 in period 2:

Note that the report of 26 is the default – this would be amended to the actual report prior to transmission of Tx2 or Tx3; once sent it should not be altered during the remainder of the QSO.

The GM4VVX sends a message to the ON4KST chat room such as:

- /cq G8BCG Hi Peter, calling you on 70.232 VVX 2nd JT6M

G8BCG should set up the equivalent complementary text box and send the required information (initially Tx1) in period-1:

Again, note that the report of 26 is the default – this would be amended to the actual report prior to transmission of Tx2 or Tx3; once sent it should not be altered during the remainder of the QSO. (Note that the serial number to be sent is in the normal sequence of contest serial numbers).

Once he is transmitting in period-1 G8BCG might respond with a message via ON4KST such as: /cq GM4VVX RR Clive, now running.

## IARU-R1

Upon receipt of both calls, G8BCG should

- Enter GM4VVX in his log, and also the locator if received
- Send calls, report and serial number (in this case 005) (his Tx2):  
GM4VVX G8BCG 26 005 26 005

When this information is received, GM4VVX will

- Log the received report as 26 and the serial number as 005 in his log
- Respond with (Tx3):

G8BCG GM4VVX R26 001 R26 001

The R is added to confirm receipt of the report and serial number, with the full calls sent again

When received correctly, G8BCG would

- Log the received report as 26 and the serial number as 001 in his log (note that the R is not logged, since it is the equivalent of “Roger” in SSB QSOs and is not a part of the report).
- Respond with (his Tx4):  
RRRR IO70RK G8BCG

The RRRR is confirmation of the acknowledgement of receipt of report and serial number.

The full locator added with the RRRR as there is space in this Tx box. At this stage G8BCG may be shortened to BCG so the information may be passed more quickly.

Once GM4VVX has received the locator, he has everything he needs, and would

- Enter the locator in his log book if not entered earlier
- Respond with:

73 IO78TA GM4VVX or 73 IO78TA VVX

this confirms receipt of all required details, including locator; the full locator is added again as extra in case the other operator had not copied it earlier.

When he receives this message, G8BCG

- Logs the locator in his log book (if not previously received)
- Responds in one of the following ways by sending

73 IO70RK BCG or CQ G8BCG IO70RK

or a posting on ON4KST such as:

/cq GM4VVX tnx FB QSO Clive 73 GL

This confirms that G8BCG has also received all the information, including locator.

The contest QSO is now complete.

### 4.3.2 Responding to CQ (as sent in Tx6 above)

When not on a calling frequency or centre of activity, the response should start with Tx2 and follow the sequence shown above.

### 4.3.3 Notes:

- The example QSO above assumes that G8BCG copies both call-signs first – if GM4VVX copies both calls before receiving a report from G8BCG, he responds with Tx2, and so on (roles reversed). Reports such as 26 are standard MS reports (see Appendix). However, on tropo paths it is permissible to use RS signal reports such as 54.
- If long call-signs are in use, the report and serial number might only be sent once in Tx2 or Tx3 to fit into the available space, e.g. MM6BYZ/P GM4VVX/P R26 005
- Be aware that some operators may use a different protocol, for example some may add the serial to the RRRR or 73s so that it reads like RRRR 001 JO45VV or 73 001 JO45VV OE



## **5 ELECTRONIC CONTEST LOG EXCHANGE**

### **5.1 Introduction**

At its meeting in Vienna 1998 the VHF/UHF/Microwaves Committee has recommended the use of the Electronic Contest Log distribution format for the exchange of log information concerning IARU Region 1 Contests. This recommendation has been endorsed by the IARU R1 EC at its 1998 meeting.

The aim of the common file format is to make contest log programmers able to deliver a standard output file from their programs, to enable contest managers to receive logs via data transfer system (e.g. diskettes, Internet) introduce electronic log processing and ease submission for participants.

What media to use is not specified, and is up to the contest manager. If Internet is a reliable medium it is a good choice, however, that does not solve yet the legal issue with the responsible operators signature yet required for IARU Region 1 contests.

When a contest manager invites to a contest she/he should state if electronic log submission is possible, in what way (e.g. INTERNET) and where (managers E-mail address), just like own mailing address. Contest managers must have a validation program to make a complete validation including cross checking etc. Contest participants can use the electronic data file format to submit their logs to the contest manager in time. To be able to do this, participants must use a contest program capable of generating a REG1TEST file.

Note: Many logging programmes do not yet accept a non-numeric character for the T part of the report. Users shall check this according to the recommendation in section.

### **5.2 Logbook programs supporting EDI**

- <http://www.rudius.net/oz2m/taclog/>
- <http://www.ucxlog.org/>
- <http://www.win-test.com/>
- <http://lea.hamradio.si/~s52aa/vhfctest4win/>
- <http://saigacontest.gmxhome.de/>
- <http://www.n1mm.com/>
- <http://www.uba.be/sites/default/files/uploads/downloads/WinOnContest.zip>

### 5.3 Standard format for Electronic Contest Log Exchange (Vienna 1998)

Electronic Data Interchange - EDI-file format for contests in Region 1 above 30 MHz. This document is the specification for the Region 1 above 30 MHz contest file formats. Examples for commonly known contests are shown in the appendix.

The aim is to make contest-log programmers able to deliver a standard (file) format from their programs, to enable contest managers to receive log data through various types of digital communication systems e.g. diskettes, e-mail, etc; for electronic evaluation purposes. (Prepared by: Bo Hansen, OZ1FDJ, Søren Pedersen, OZ1FTU)

#### 5.3.1 Format

[REG1TEST;1]File identifier; file version

TName= Contest name  
 TDate= Beginning;ending date of contest  
 PCall= Callsign used  
 PWWLo= WWL used  
 PExch= Exchange used  
 PAdr1= Address line 1 from where the contest took place  
 PAdr2= Address line 2 from where the contest took place  
 PSect= Section in which station participates  
 PBand= Band used during the contest  
 PClub= Club station where points can be accumulated  
 RName= Name of responsible operator  
 RCall= Callsign of responsible operator  
 RAdr1= Address line 1 of responsible operator  
 RAdr2= Address line 2 of responsible operator  
 RPoCo= Postal code of responsible operator  
 RCity= City of responsible operator  
 RCoun= Country of responsible operator  
 RPhon= Phone number of responsible operator  
 RHBBS= Home BBS of responsible operator  
 MOpe1= Multi operator line 1  
 MOpe2= Multi operator line 2  
 STXEq= TX equipment  
 SPowe= TX power [W]  
 SRXEq= RX equipment  
 SAnte= Antenna  
 SAntH= Antenna height above ground level [m];height above sea level [m]  
 CQSOs= Claimed number of valid QSOs;Band multiplier  
 CQSOP= Claimed number of QSO-points  
 CWWLs= Claimed number of WWLs;Bonus per each new WWL;WWL multiplier  
 CWWLB= Claimed number of WWL bonus points  
 CExcs= Claimed number of Exchanges;Bonus per each new Exchange;Exchange multiplier  
 CExcB= Claimed number of Exchange bonus points  
 CDXCs= Claimed number of DXCCs;Bonus per each new DXCC;DXCC multiplier  
 CDXCB= Claimed number DXCC bonus  
 CToSc= Claimed total score  
 CODXC= Call;WWL;distanceBest DX contact  
 [Remarks]Remarks identifier  
 Remarks lines

## IARU-R1

[QSORecords;Number of QSO records following]QSO records identifier;number of QSO records following Date;Time;Call;Mode code;Sent-RST;Sent QSO number;Received-RST;Received QSO number; Received exchange;Received-WWL;QSO-Points;New-Exchange-(N);New-WWL-(N);New-DXCC-(N);Duplicate-QSO-(D)

### 5.3.2 Explanation of keywords in header

Keywords are defined as the word in front of the actual argument. The keyword is separated from the argument with an equal sign (=).

[REG1TEST;1]

REG1TEST;1 is the file identifier and the file version. It serves as indicator for which format and version is being used and where data begins.

#### **TName**

Argument describes the name of the contest in which the station participated.

#### **TDate**

Arguments describe the beginning and ending dates of the contest. Arguments are separated with a semicolon (;). Arguments are written as YYYYMMDD.

#### **PCall**

Argument describes the callsign used during the contest.

#### **PWWLo**

Argument describes own World Wide Locator (WWL, Maidenhead, Universal Locator) used during the contest. Maximum length is six characters.

#### **PExch**

Argument describes own Exchange during the contest. This can be any type of information, e.g. Province, DOK, County, State, Power, Name. Maximum length is six characters.

#### **PAdr1**

Argument describes the address of the QTH used during the contest, line 1.

#### **PAdr2**

Argument describes the address of the QTH used during the contest, line 2.

#### **PSect**

Argument describes in which section the station is participating. Synonyms to the meaning Asection@ are: class, category, group etc.

Section	PSection
SINGLE	SO, SINGLE, SINGLE-OP
MULTI	MO, MULTI, MULTI-OP
6 HOURS SINGLE	SO-6H, SINGLE-OP-6H
6 HOURS MULTI	MO-6H, MULTI-OP-6H
SINGLE with MGM	SO-MGM, SINGLE-OP-MGM
MULTI with MGM	MO-MGM, MULTI-OP-MGM

#### **PBand**

Argument describe which band was used during the contest. Please note the bands and which frequency range they represent in the table below:

Frequency	PBand
50 - 54 MHz	50 MHz
70 - 70,5 MHz	70 MHz
144 - 148 MHz	145 MHz
430 - 440 MHz	435 MHz
1240 - 1300 MHz	1,3 GHz
2300 - 2450 MHz	2,3 GHz
3400 - 3600 MHz	3,4 GHz
5650 - 5850 MHz	5,7 GHz
10,0 - 10,5 GHz	10 GHz
24,0 - 24,25 GHz	24 GHz

#### IARU-R1

47,0 - 47,2 GHz	47 GHz
75,5 - 81 GHz	76 GHz
120 - 120 GHz	120 GHz
142 - 148 GHz	144 GHz
241 - 250 GHz	248 GHz

#### **PClub**

Argument describes the callsign of the radio club where operator(s) are member. Can be used if points are accumulated to the club etc.

#### **RName**

Argument describes the given- and surname of the responsible operator.

#### **RCall**

Argument describes the callsign of the responsible operator.

#### **Adr1**

Argument describes the address of the responsible operator, line 1.

#### **RAdr2**

Argument describes the address of the responsible operator, line 2.

#### **RPoCo**

Argument describes the postal code of the responsible operator.

#### **RCity**

Argument describes the city of the responsible operator.

#### **RCoun**

Argument describes the country of the responsible operator.

#### **RPhon**

Argument describes the telephone number of the responsible operator.

#### **RHBBS**

Argument describes the Bulletin Board System or electronic mail address of the responsible operator.

#### **MOpe1**

Arguments describe the operators participating in the contest, line 1. All arguments separated with a semicolon (;). Responsible operator is not needed in this argument.

#### **MOpe2**

Arguments describe the operators participating in the contest, line 2. All arguments are separated with a semicolon (;). Responsible operator is not needed in this argument.

#### **STXEq**

Argument describes the transmitting equipment used during the contest.

#### **SPowe**

Argument describes the transmitting power used during the contest, unit is Watt.

#### **SRXEq**

Argument describes the receiving equipment used during the contest.

#### **SAnte**

Argument describes the antenna system used during the contest.

#### **SAntH**

Arguments describe the antenna height above ground level and sea level, unit is meter. All arguments separated with a semicolon (;).

#### **CQSOs**

Arguments describe the claimed number of valid QSOs and the band multiplier. All arguments are separated with a semicolon (;).

#### **CQSOP**

Argument describes the claimed total number of QSO-points. The format does not specify that QSO-points can only be based upon distances.

#### **CWWLs**

Arguments describe the claimed number of WWLs worked, the number of bonus points claimed for each new WWL and the WWL multiplier. All arguments are separated with a semicolon (;).

#### IARU-R1

If no bonus points are claimed then bonus points per each new WWL are set to zero (0). If no multiplication is used for each new WWL the multiplier is set to one (1).

#### **CWWLB**

Argument describes the claimed total number of WWL bonus points.

#### **CExcs**

Arguments describe the claimed number of Exchanges worked, the number of bonus points claimed for each new Exchange and the Exchange multiplier. All arguments are separated with a semicolon (;).

If no bonus points are claimed then bonus points per each new Exchange are set to zero (0). If no multiplication is used for each new Exchange the multiplier is set to one (1).

#### **CExcB**

Argument describes the claimed total number of Exchange bonus points.

#### **CDXCs**

Arguments describe the claimed number of DXCCs worked, the number of bonus points claimed for each new DXCC and the DXCC multiplier. All arguments are separated with a semicolon (;).

If no bonus points are claimed then bonus points per each new DXCC are set to zero (0). If no multiplication is used for each new DXCC the multiplier is set to one (1).

#### **CDXCB**

Argument describes the claimed total number of DXCC bonus points.

#### **CToSc**

Argument describes the total claimed score. The format does not specify how the total score is calculated.

#### **CODXC**

Arguments describe the claimed ODX contact call, WWL and distance. All arguments are separated with a semicolon (;).

#### **[Remarks]**

The [Remarks] identifier is used to mark where the Remarks begins. All lines following, until [QSORecords;Number of QSO records following], are remarks. If no remarks are written identifier must still be present.

Remarks lines

Remarks lines are where the station may write comments to the test. The number of lines is variable. All lines in between [Remarks] and [QSORecords;Number of QSO records following] are remarks.

#### **[QSORecords;Number of QSO records following]**

The [QSORecords;Number of QSO records following] is the QSO record identifier used to mark where QSO records begins, and how many consecutive QSO records to follow.

**5.3.3 QSO record definition**

Date;Time;Call;Mode code;Sent-RST;Sent QSO number;Received RST;Received QSO number;Received Exchange;Received-WWL;QSO-Points;New-Exchange-(N);New-WWL-(N);New-DXCC-(N);Duplicate-QSO-(D) All arguments are separated with a semicolon (;).All fields in the QSO record is written on the same line, and ending with ASCII characters 13 and 10 (CR LF).

<b>Field</b>	<b>Content</b>	<b>Maximum</b>	
Date	YYMMDD, 6 characters		6
Time	UTC, 4 characters, with leading zeros		4
Call	3 to 14 characters		14
Mode code	0 or 1 character		1
Sent-RST	0 or 2 or 3 characters		3
Sent QSO number	0 or 3 or 4 characters, with leading zeros		4
Received-RST	0 or 2 or 3 characters		3
Received QSO number	0 or 3 or 4 characters, with leading zeros		4
Received Exchange	0 or 1 to 6 characters (see also PExch)		6
Received WWL	0 or 4 or 6 characters, World Wide Locator		6
QSO points	1 to 6 characters, including bandmultiplier		6
New-Exchange	0 or 1 character, "N" if QSO is a new exchange		1
New-WWL	0 or 1 character, "N" if QSO is a new WWL		1
New-DXCC	0 or 1 character, "N" if QSO is a new DXCC		1
Duplicate-QSO	0 or 1 character, "D" if contact is a duplicate QSO		1
			61
			+ field separators, 14 = 75

**Mode code**

The mode code is used to show which modes were used for the QSO. Below is a list of the code with corresponding modes.

<b>Mode code</b>	<b>TX mode</b>	<b>RX mode</b>
0	none of below	none of below
1	SSB	SSB
2	CW	CW
3	SSB	CW
4	CW	SSB
5	AM	AM
6	FM	FM
7	RTTY - MGM	RTTY – MGM (Varna 2014)
8	SSTV	SSTV
9	ATV	ATV

If the mode is not important it can be left blank, i.e. not stated in rules/invitation.

**5.3.4 Characters**

Used characters are in accordance with the 7-bit ASCII alphabet and only characters with the following decimal number are allowed 10, 13, 32-127.

**5.3.5 Line length**

If line length is already specified it must not be exceeded, other lines must not exceed a length of 75 characters. Length is limited due to Packet Radio transferral.

All lines, in the format description, with the "F" denote that entry is a *free format*. This means that any of the above characters in the 7-bit ASCII alphabet can be used.

## IARU-R1

All other entries are *forced format* and characters, as above, are in capital. All numbers in forced format are positive integers and non-exponential notation and entry cannot be left empty, i.e. 0 (zero) or greater. All forced formats must be in accordance with SI-units (Système International).

### 5.3.6 Separator (;)

This separator semicolon (;) is written to separate multiple information on same line.

If the format is used for a contest which does not use some of the QSO exchanges, i.e. QSO no., WWL and Exchange, these fields are left blank. Proper interpretation must be ensured by manager program.

### 5.3.7 Faulty QSOs

A duplicate QSO is marked with a "D" in the Duplicate-QSO field, and the QSO-points field is set to 0 (zero). The format does not define when a QSO is a duplicate.

An incomplete QSO is written with the information received, and the QSO-points field is set to zero (0).

In case of a mistake, an error mark must be inserted in the Callsign field to keep a correct flow in the number of QSOs records. The error mark must be an "ERROR" and the other fields except Time and Sent QSO no., if used, can be left empty. In case the empty field is accumulated, e.g. QSO-points, it is set to 0 (zero).

### 5.3.8 QSO numbers

The format does not define in what order the QSO numbers must be listed. It is possible to use the format to submit logs for contests requiring consecutive numbers for all QSOs, even if they are on different bands.

### 5.3.9 Missing information

If a contest log program cannot fill in all the information, the missing information can be left blank, except if information is needed for claiming/calculating scores, e.g. log program cannot identify WWLs, DXCCs etc. If the information is required for the scores this log program cannot be used for this particular contest anyway.

The following section describes different EDI-files for various commonly known contest types.

### 5.3.10 Example: Region 1 Contest, standard type

[REG1TEST;1]

TName=IARU Region 1, March contest VHF

TDate=19950304;19950305

PCall=OZ1FDJ

PWWLo=JO65FR

PExch=

PAdr1=Herlevgaardsvej 32 A, st. tv., DK-2730 Herlev

PAdr2=

PSect=Multi operator

PBand=144 MHz

PClub=OZ2AGR

RName=Bo Hansen

RCall=OZ1FDJ

RAdr1=Herlevgaardsvej 32 A, st. tv.

RAdr2=

RPoCo=DK-2730

RCity=Herlev

RCoun=DENMARK

RPhon=(+45) 42 91 53 98

RHBBS=OZ6BBS

IARU-R1  
MOpe1=OZ1FTU  
MOpe2=  
STXEq=FT-225RD+MRF247  
SPowe=90  
SRXEq=FT-225RD+MuTek+BF981 1,5 dB NF  
SAnte=9 elements OZ5HF  
SAntH=14;41  
CQSOs=24;1  
CQSOP=11579  
CWWLs=19;0;1  
CWWLB=0  
CExcs=0;0;1  
CExcB=0  
CDXCs=7;0;1  
CDXCB=0  
CToSc=11579  
CODXC=OY9JD;IP62OA;1302

[Remarks]

Nice with the Aurora, made it possible to work more than usual in a 24 h contest. Nice to hear Jon (OY9JD) again, but, many stations calling so no time for chat.

Besides the Aurora there was only little activity, as usual, in Scandinavia.

[QSORecords;26]

950304;1445;OZ9SIG;1;59;001;59;006;;JO65ER;6;;N;N;  
950304;1446;DL5BBF;1;54;002;59;023;;JO42LT;396;;N;N;  
950304;1449;OZ1HLB/P;1;59;003;59;015;;JO55US;48;;N;;  
950304;1450;DL6FBL;1;53;004;51;092;;JO40XL;608;;N;;  
950304;1454;DF0TAU;1;54;005;59;084;;JO40QO;606;;;;  
950304;1508;DJ3QP;1;55;006;59;095;;JO42FB;485;;;;  
950304;1510;DG5TR;1;53;007;53;006;;JO53QP;242;;N;;  
950304;1519;DL0WU;1;55;008;53;108;;JO31OF;609;;N;;  
950304;1528;DL3LAB;1;59;009;59;046;;JO44XS;191;;N;;  
950304;1532;DL5XV;1;56;010;59;033;;JO53AO;283;;;;  
950304;1544;OZ8RY/A;1;56;011;57;010;;JO66HB;39;;N;;  
950304;1553;OZ1A0O;1;59;012;59;001;;JO65FR;1;;;;  
950304;1603;ERROR;;;013;;;;0;;;;  
950304;1618;DL0WX;1;53;014;52;174;;JO30FQ;688;;N;;  
950304;1626;SM4HFI;2;53A;015;54A;019;;JP70TO;573;;N;N;  
950304;1631;GM4YXI;2;57A;016;55A;015;;IO87WI;911;;N;N;  
950304;1636;OH2AAQ;2;52A;017;59A;015;;KO29FX;851;;N;N;  
950304;1640;OH2BNH;2;55A;018;57A;024;;KP20LG;891;;N;;  
950304;1641;LA2AB;1;59A;019;57A;027;;JO59FV;479;;N;N;  
950304;1646;SM5BSZ;2;55A;020;57A;029;;JO89IJ;480;;N;;  
950304;1700;SK5BN;2;51A;021;55A;026;;JP80UE;585;;N;;  
950304;1720;DL9LBA;2;529;022;559;056;;JO44UP;213;;;;  
950304;1730;SK6NP;2;559;023;539;029;;JO68MB;262;;N;;  
950304;1736;OH1MDR;2;52A;024;57A;023;;KP01VJ;830;;N;;  
950304;1739;OY9JD;2;51A;025;52A;011;;IP62OA;1302;;N;N;  
950304;1826;OZ9SIG;1;59;026;59;006;;JO65ER;0;;;;D



IARU-R1

**5.3.11 Example : AGCW DL VHF Contest (contest manager: DJ2QZ)**

[REG1TEST;1]

TName=AGCW contest 2 m

TDate=19950318;19950318

PCall=OZ1FDJ

PWWLo=JO65FR

PExch=C

PAdr1=Herlevgaardsvej 32 A, st. tv., DK-2730 Herlev

PAdr2=

PSect=C

PBand=144 MHz

PClub=OZ2AGR

RName=Bo Hansen

RCall=OZ1FDJ

RAdr1=Herlevgaardsvej 32 A, st. tv.

RAdr2=

RPoCo=DK-2730

RCity=Herlev

RCoun=DENMARK

RPhon=(+45) 42 91 53 98

RHBBS=OZ6BBS

MOpe1=

MOpe2=

STXEq=FT-225RD+MRF247

SPowe=90

SRXEq=FT-225RD+MuTek+BF981 1,5 dB NF

SAnte=9 elements OZ5HF

SAntH=14;41

CQSOS=24;1

CQSOP=11579

CWWLs=19;500;1

CWWLB=9500

CExcs=3;0;1

CExcB=0

CDXCs=7;0;1

CDXCB=0

CToSc=11579

CODXC=OY9JD;IP62OA;1302

[Remarks]

Nice with the Aurora, made it possible to work more than usual.

Nice to hear Jon (OY9JD) again, but, many stations calling so no time for chat.

Besides the Aurora there was only little activity, as usual, in Scandinavia.

[QSORecords;26]

950318;1600;OZ9SIG;2;599;001;599;006;B;JO65ER;6;N;N;N;

950318;1602;DL5BBF;2;549;002;599;023;C;JO42LT;396;N;N;N;

950318;1607;OZ1HLB/P;2;599;003;599;015;C;JO55US;48;N;;

950318;1609;DL6FBL;2;539;004;519;092;C;JO40XL;608;N;;

950318;1614;DF0TAU;2;549;005;599;084;B;JO40QO;606;;;;

950318;1618;DJ3QP;2;559;006;599;095;C;JO42FB;485;;;;

950318;1625;DG5TR;2;539;007;539;006;A;JO53QP;242;N;N;;

950318;1628;DL0WU;2;559;008;539;108;C;JO31OF;609;N;;

950318;1630;DL3LAB;2;599;009;599;046;C;JO44XS;191;;N;;

IARU-R1

950318;1632;DL5XV;2;569;010;599;033;C;JO53AO;283;;;;  
950318;1644;OZ8RY/A;2;569;011;579;010;A;JO66HB;39;;N;;  
950318;1653;OZ1A00;2;599;012;599;001;A;JO65FR;1;;;;  
950318;1703;ERROR;;;013;;;;;0;;;;  
950318;1718;DL0WX;2;539;014;529;174;C;JO30FQ;688;;N;;  
950318;1726;SM4HFI;2;53A;015;54A;019;C;JP70TO;573;;N;N;  
950318;1731;GM4YXI;2;57A;016;55A;015;C;IO87WI;911;;N;N;  
950318;1736;OH2AAQ;2;52A;017;59A;015;C;KO29FX;851;;N;N;

IARU-R1

## **5.4 AUTOMATIC CONTEST ADJUNCTION SOFTWARE**

In this section we will explain the working of the contest robot and give guidelines for other member societies who want to make their own contest robot. (Vienna 2016)



# PART 4

## OPERATIONAL & TECHNICAL REFERENCES

## **1 OPERATING PROCEDURES**

### **1.1 Minimum Requirement for a valid QSO**

A definition for a valid QSO on VHF and on higher bands is:-

A valid contact is one where both operators during the contact have

- mutually identified each other
- received a report, and
- received a confirmation of the successful identification and the reception of the report.

*It is emphasized that the responsibility always lies with the operator for the integrity of the contact.*

## 1.2 Weak-signal QSO procedure

Terrestrial signals may often be heard on the VHF bands that are weak and suffering from considerable fading. It will be helpful in these circumstances to be able to resort to an operating procedure that maximises the possibility of a contact.

The procedure described here is primarily for CW and SSB contacts although the principle may be adapted for other communication techniques if required.

### 1.2.1 The Basis of the Procedure

Imagine that two stations can hear each other but signals are very weak and suffering from considerable fading. This is often experienced on the 50MHz, 70MHz and 144MHz bands during poor tropospheric propagation conditions. These two stations may attempt to contact each other but can often be transmitting (or receiving) at the same time. Therefore the QSO is most likely to fail. Somehow you need to be able to drop into a timed period mode to enhance the chance of making a QSO. But which station starts the first timed period?

This may simply be achieved from the way you are beaming your directional antenna.

So, for example, if you hear a station when you are beaming WEST (or NORTH) and \*hopefully\* the other station is beaming EAST (or SOUTH) then both stations can drop into a timed sequence because they will know approximately where the other station is.

### 1.2.2 Procedure

The weak-signal QSO procedure commences by ascertaining from your beam-heading which station starts the first 1-minute period.

- If you are beaming SOUTH or EAST you start the first (even) 1-minute period.  
For example: 00-01, 02-03, 04-05 ..... and so on 54-55, 56-57, 58-59....
- If you are beaming NORTH or WEST you start in the second (odd) 1-minute period.  
For example: 01-02, 03-04, 05-06 ..... and so on 55-56, 57-58, 59-60....

Stations alternately call each other until signals are heard.

- QRZ G4ASR ... QRZ G4ASR ... OVER ( or K on CW)

When the call sign of the calling station is heard insert a conventional tropo report (3 times)

- F6ETI G4ASR 52 52 52 ... F6ETI G4ASR 52 52 52 ... OVER (K)

Reply with a confirmation roger report (3 times)

- G4ASR F6ETI R57 R57 R57 ... G4ASR F6ETI R57 R57 R57 ... OVER (K)

Confirm with a string of rogers (3 times)

- F6ETI G4ASR Roger Roger Roger ... OVER (K)
- G4ASR F6ETI Roger Roger Roger ... OVER (K)

### 1.2.3 Valid Contacts

A valid contact is one where each operator has copied both call signs, the report and a confirmation that the other operator has done the same. This confirmation may either be an "R" preceding the report or a string of three consecutive "rogers" (RRR).

This procedure may also be used for contest contacts by inserting the appropriate contest exchange requirements within the 1-minute periods.

## **1.3 Operating code of practice for 50 MHz operators**

### **1.3.1 50 MHz as a DX band**

It should be recognised by all 50 MHz operators that 50 MHz is a DX band. All 50 MHz operators should always treat each other with respect and tolerance.

### **1.3.2 Band plan**

Always respect the band plan as issued by IARU, taking into account the conditions of your license.

### **1.3.3 Local QSO's**

Do not conduct local QSO's within the 50.100 to 50.130 MHz window for Intercontinental contacts.

### **1.3.4 Learn to listen**

True 50 MHz band DX'ers spend about five percent of their time transmitting while ninety-five percent of time is spent listening and observing changing band conditions and propagation modes. This will be far more effective than just calling CQ DX at random.

### **1.3.5 50.100 - 50.130 MHz window for intercontinental contacts**

This Window is widely accepted and should be used for Inter-continental QSO's only.

### **1.3.6 50.110 MHz Intercontinental calling frequency**

This should be used for Intercontinental contacts only. Do not under any circumstances engage in local continental QSO's on this frequency even for a minute or two. Do not encourage pile-ups on 50.110 MHz.

### **1.3.7 50.110 MHz CQ'ing**

LISTENING is the first rule of working rare DX on the 50 MHz band. So think twice before calling CQ on 50.110 MHz. But the occasional CQ is good as it can discover an unrecognised opening.

### **1.3.8 QSO techniques**

Follow the style and take the lead of the DX operator in providing information. Otherwise keep it simple as there are other stations waiting in line.

### **1.3.9 DX pile-up operating**

You should listen to the DX stations carefully and not continue to call if they request a particular country or prefix if that is not you. You should NOT call if you cannot hear the DX station!

### **1.3.10 Split frequency operation**

When a DX station creates a large pile-up, split-frequency operation is recommended. To minimise interference with other DX stations operating simplex, it is recommended that a maximum split of 10 kHz is used.

### **1.3.11 Duplicate QSO's**

It is always tempting to call a rare DX station every time you hear it. This should be avoided as it means that you are taking away the opportunity for the DX station to work a new station and give them their first QSO with the DX country.

### **1.3.12 Telegraphy operation**

Telegraphy is probably the best mode of operation on the 50 MHz band due to the nature of many DX openings.

### **1.3.13 FM QSO's in Europe**

All FM transmissions should be made above 50.500 MHz for the obvious reason that FM is wideband and could wipe out weak DX signals.

### **1.3.14 Mutual interference**

Proper adjustment of transmitters will minimise distortion and reduce interference with operators on nearby frequencies. The correct level of audio setting for the microphone in use is essential for readability and minimal distortion. Linear amplifiers should be only driven so that they operate in the linear region and in any case should only be used when propagation conditions require it. Please note that poor receiver performance with respect to adjacent channel rejection and overload will also limit your effectiveness.

## 1.4 Operating procedures for Meteor Scatter QSO's

### 1.4.1 Introduction

The goal of the procedures described is to enable valid contacts to be made by meteor scatter (MS) reflection as quickly and easily as possible. Meteor scatter is unlike most other propagation modes, in that neither station can hear the other until an ionised meteor trail exists to scatter or reflect the signals. As the reflections are often of very short duration the normal QSO procedure is not readily applicable and specialised operating techniques must be taken to ensure that a maximum of correct and unmistakable information is received. The two stations have to take turns to transmit and receive information in a defined format, following the procedures as detailed below. Some meteor showers are strong enough to make some of these measures unnecessary, but to encourage use of all generally listed showers there is no reason why the suggested procedures should not always be used. As with operating procedures in general, the virtues of the MS operating procedures are mainly that they are standard and are widely understood throughout IARU Region 1.

### 1.4.2 Scheduled and Random Contacts

Two types of MS contacts, arranged in different ways, may be distinguished:

- A scheduled contact, where two interested stations arrange in advance the frequency, timing, transmission mode, e.g. Telegraphy, SSB or MGM and call signs to be used. Scheduling may be carried out by exchange of letters or e-mail, by radio via the European VHF Net on 14,345 MHz, by Internet chat-rooms, packet-radio etc.
- A non-scheduled contact, where a station calls CQ or responds to a CQ call, are called "random contacts". Random contacts are far more difficult and because you are starting entirely from scratch, it is particularly important for both stations to follow the standard meteor scatter QSO procedures described in this document.

### 1.4.3 Timing

Prior to any MS activity it is absolutely vital that clocks need to be set to better than 1 second of standard time. Any clock inaccuracy will result in wasted time. Accurate timing of transmit and receive periods is important for two reasons: 1) to maximise the chances of hearing the other station, and 2) to avoid interference between local stations. Accurate timing can be accomplished for example by checking against the time-ticks on standard frequency transmissions, TV Teletext, telephone 'speaking-clock', GPS time signals or the Internet.

The recommended time periods for the different modes are:

- Telegraphy: 2.5 minutes periods.
- SSB: 1 minute periods.
- MGM: 30 seconds periods.

This practice gives quite satisfactory results. However developing technology make it possible to use much different periods and amateurs may wish to arrange 1 minute periods for Telegraphy and shorter periods for SSB and MGM especially during major showers. If non-recommended time periods are used the first priority is to avoid causing interference to local stations that are using the recommended periods. Even though the recommended period for SSB contacts is 1 minute periods a quick-break procedure making a break every 10-15 seconds, in case the QSO can be completed within one long burst, are encouraged during major meteor showers.

### 1.4.4 Transmit periods

In order to minimise the overall interference with other stations standard transmit periods are recommended. Station in central and Western Europe should use second period. All MS operators living in the same area should, as far as possible, agree to transmit simultaneously in order to avoid mutual interference.



### 1.4.5 QSO duration

Every uninterrupted QSO period must be considered as a separate trial. This means that it is not permissible to break off and then continue the contact at a later time.

### 1.4.6 Frequencies

#### Scheduled contacts

These contacts may be arranged on any frequency, taking into consideration the mode and band plan. Scheduled contacts must not use known popular frequencies and the random MS frequencies. Special care should be applied on the frequency selection to avoid interference when using reverse transmit periods according to your location.

#### Random contacts

The frequency used for CQ calls for random contacts should be according to the IARU Region 1 bandplans.

### 1.4.7 QSY frequencies for MGM

To avoid -interference, which results from a large number of stations attempting to complete contacts on the various MS calling frequencies, a QSY method is recommended. During the CQ the caller indicates on which frequency he/she will listen for a reply and carry out any subsequent QSO. The procedure for moving a beginning QSO off the calling frequency without losing contact is as follows. If an operator wants to call CQ the following QSY procedure should be used:

- Select the frequency to be used for a QSO by checking whether it is clear of traffic and QRM.
- In the CQ call, immediately following the letters "CQ", kHz is inserted to indicate the frequency that will be used for reception when the CQ call finishes.
- During the receiving period the receiver should be tuned to the frequency indicated by the letter used in the CQ call.
- When the caller receives a signal on the receiving frequency indicated during the call and identifies the reply as an answer on his CQ, the transmitter is moved to the same receiving frequency and the whole QSO procedure takes place there.

If an operator instead of calling CQ wishes to listen for a CQ call the following QSY-procedure should be used:

- Listen on a random contact frequency.
- When a CQ call is received, note the kHz-frequency, which follows the letters "CQ" in the call. From this find the correct receiving frequency which the calling station will use for receiving replies.
- QSY the transmitter to the receiving frequency, and transmit a reply during the appropriate period. The format for the reply can be found in section 8.
- As the QSO will take place on this frequency, continue to transmit and to listen, during the appropriate periods, on this frequency. It may be that the station calling CQ will not hear your first reply, but may do so during one or more subsequent periods. Hence there is no need to return to the calling frequency.
- The QSY frequencies should take place in the segment according to the IARU Region 1 bandplans.

- **MGM, kHz-frequency**

Users of MGM indicate the frequency they intend to carry out the QSO by adding the three digits of the absolute frequency, i.e. the kHz-frequency. For example CQ383 indicates that the station will listen on 144,383 MHz for a subsequent contact.

**Example:** G4ASR wishes to try a random MS experiment on MGM and wants to start with calling CQ. He first checks his receiver in the MGM range of 144,360 MHz to 144,397 MHz and finds a clear frequency on 144,394 MHz. He calls CQ on 144,370 MHz, and he must now add the kHz-

## IARU-R1

frequency to his CQ call to indicate on which frequency he intends to listen. In this example he will therefore call "CQ394" in his CQ call.

**Example:** You receive PA2DW who is calling "CQ274" on the 50 MHz random frequency. This tells you that PA2DW will listen on exactly 50,274 MHz.

- **CW/SSB**

This proposal does not describe any procedures for QSY operation on CW/SSB anymore.

### 1.4.8 QSO procedure

All modes use the same MS-QSO procedure.

When attempting random SSB contacts, speak the letters clearly, using phonetics where appropriate.

- **Calling**

The contact starts with one station calling the other by sending both call signs.

- **Reporting system**

The report consists of two numbers:

---

<i>First number</i>	<i>Second number (signal strength)</i>
---------------------	--

---

<b>burst duration</b>	<b>S-units S/N</b>
-----------------------	--------------------

2 : up to 0,5 s	6 : below S2 or below 5 dB
-----------------	----------------------------

3 : 0,5 - 1 s	7 : from S2 to S3 or from 5 dB to 10 dB
---------------	---

4 : 1 - 5 s	8 : from S4 to S5 or from 10 dB to 15 dB
-------------	--

5 : longer than 5 s	9 : above S5 or above 15 dB
---------------------	-----------------------------

Note that the number "1" is not used as the first number/burst duration.

Maximum duration of a ping (Underdense Reflection):

<b>Band</b>	<b>Duration</b>
-------------	-----------------

50 MHz	1000 ms
--------	---------

70 MHz	500 ms
--------	--------

144 MHz	100 ms
---------	--------

432 MHz	13 ms
---------	-------

This means that the duration of bursts (Overdense Reflections) are longer than the above ping durations.

- **Reporting procedure**

A report is sent when the operator has positive evidence of having received the correspondent's or his own callsign or parts of one of them. The report should be sent twice between each set of call signs. The report must not be changed during a contact even though signal strength or duration might well justify it.

- **Confirmation procedure**

- As soon as either operator copies both call signs and a report he may start sending a confirmation. This means that all letters and figures have been correctly received. The message can be pieced together from fragments received over several bursts and pings, but it is up to the operator to ensure that it is done correctly and unambiguously. Confirmation is given by inserting an R before the report.
- When one operator receives a confirmation message, such as "R27", and all required information is complete he must confirm with a string of R's, inserting his own call sign after at least 3 R's. When the other operator has received the R's, the contact is complete and he may respond in the same manner.

IARU-R1

- **Requirements for a complete QSO**

Both operators must have copied both callsigns, the report and a confirmation that the other operator has done the same. This confirmation can either be an "R" preceding the report or a string of minimum three consecutive "RRR".

#### **1.4.9 Valid contacts**

A valid contact is one where both operators have copied both callsigns, the report and an unambiguous confirmation. However no recourse should be made during the contact to obtain the required information, change of frequency, antenna direction, etc. via other methods such as the Internet, DX Cluster, talk-back on another band, telephone etc. Such secondary methods invalidate the meteor scatter contact.

In essence: if anything concerning the ongoing QSO attempt is agreed through other means than the QSO attempt frequency a new start is required.

#### **1.4.10 Additional information for communication before and during the MS QSO**

##### **Acceptable examples:**

- *“shall we make a sked on 144.388 starting at 1310z, I will start”*
- *“I have QRM, let’s move 5 kHz up and start again”*
- *“let’s continue for another 15 minutes and start again”*
- *“thank you for a nice QSO” after the QSO has completed on the radio”*

##### **Unacceptable Examples:-**

- *“I only need the final rogers”*
- *“470/9”*
- *“I received a burst from you”*
- *“I received a burst from you but I cannot decode it”*

## 1.5 QSO Procedure for Airplane Reflections

Airplane Reflections is the process of reflecting radio waves off the body of an aircraft in flight. Contacts may be made on any of the UHF or Microwaves bands with distances up to 800 kilometres or so away. (The higher the frequency, the shorter the time you have). As the available time for a QSO in this propagation mode is very brief, usually less than one minute, we need an operating procedure in order to speed up the information exchange.

The scheme (not the reporting system) for the "old" MS procedure seems like a suitable model for this purpose. This procedure is primarily for CW and SSB contacts but may be adapted for other communication modes if required.

### 1.5.1 Calling

The contact starts with one station calling randomly (CQ), - or in a scheduled QSO: Calling the other station by sending both call signs. A calling sequence should be kept as short as possible.

### 1.5.2 Reporting system

The report is the standard RS(T) reporting system: as example 59 or 599.

### 1.5.3 Reporting procedure

A report is sent when the operator has positive evidence of having received the correspondent's or his own callsign or parts of them. The report should be sent at least twice between each set of call signs. The report must not be changed during a contact even though signal strength or duration might well justify it.

### 1.5.4 Confirmation procedure

As soon as either operator copies both call signs and a report he may start sending a confirmation. This means that all letters and figures have been correctly received. The message can be pieced together from fragments, but it is up to the operator to ensure that it is done correctly and unambiguously. Confirmation is given by inserting an R before the report. When one operator receives a confirmation message, such as "R57", and all required information is complete he must confirm with a string of R's, inserting his own call sign after at least 3 R's. When the other operator has received the R's, the contact is complete and he may respond in the same manner.

### 1.5.5 Requirements for a complete QSO

Both operators must have copied both callsigns, the report and a confirmation that the other operator has done the same. This confirmation can either be an "R" preceding the report or a string of minimum three consecutive "RRR".

And in practice:

If you start calling CQ:

CQ G4ASR ...CQ G4ASR ... CQ G4ASR ... BREAK ( or K on CW)

Or starting a scheduled QSO:

SM7ECM G4ASR... BREAK ( or K on CW)

When signals are heard insert a conventional tropo report (usually 2 - 3 times)

SM7ECM G4ASR 52 52 52... BREAK (K)

Reply with a confirmation roger report (usually 2 - 3 times)

[G4ASR SM7ECM] R57 R57 R57 ... BREAK (K)

Confirm with a string of rogers (usually 3 times)

[SM7ECM G4ASR] Roger Roger Roger...BREAK (K)

[G4ASR SM7ECM] Roger Roger Roger...BREAK (K)

Usually QSOs made via Airplane reflections is conducted on random frequencies. As a consequence the callsigns could be eliminated when first copied correctly. For contest purposes you have to add the contest exchange i.e. the Locator.

## **1.6 Rapid Deployment Amateur Radio (RaDAR)**

### **1.6.1 Introduction**

Rapid Deployment Amateur Radio, often referred to by its acronym RaDAR, is a concept for operating an amateur radio station anywhere, anytime and even in adverse environmental conditions. This concept supports the amateur radio service's emergency communications mandate.

### **1.6.2 The concept**

Rapid deployment and indeed rapid redeployment is what makes RaDAR different otherwise it would be just the same as all the others nothing different to what has been done for a 100 years.

RaDAR has evolved into something where movements are the highlight. It is therefore more than just making QSOs, it's a challenge to decide quickly where and how to set up an effective station, proving it works by making 5 contacts; packing up making sure nothing is left behind, moving and doing it all over again.

It's a different challenge including repeated physical activity. It's also a method of learning, practising and finding what works and what does not.

### **1.6.3 Modes of communication**

RaDAR promotes the use of voice, digital, CW, HF, point to point VHF and UHF communications and even satellite communications. The use of terrestrial repeaters is however not allowed, for contest purposes at least.

### **1.6.4 Summary**

Many looking to practice amateur radio in different ways will see its value and the extreme fun it can be. The highlight is the "moving" aspect of RaDAR which is what makes RaDAR different to all other amateur radio activities.

A link will be made on the IARU R1 website to give more information about RaDAR.

## 1.7 Operating practice for digital modes

### 1.7.1 Guidelines for Packet Radio Operators

- Amateur Radio takes pride in being self-regulated. Packet Radio Operators should continue this tradition.
- Packet Radio Operators, like all Amateur Radio Operators, should observe published Band Plans.
- A Packet Radio Operator should not send the following traffic either direct or via mail boxes:
- All advertising for selling, buying or trading goods, including amateur equipment (except if permitted by local regulations).
- All statements and/or propaganda on political or religious subjects.
- All inappropriate language, as, for instance, the use of swear words, obscenities, defamatory or libellous language etc.
- All material which may infringe copyright.
- All material which infringes privacy, whether personal or corporate.
- A Packet Radio Operator utilising a BBS should avoid transmitting unnecessary or redundant messages and documents in order to enhance network efficiency.
- A Packet Radio Operator utilising a BBS should ensure that the callsign of the originating station, including the name of the person responsible in the case of a club station, is clearly shown on every message so that the sender can be identified.
- A Packet Radio Operator should avoid messages that are too long for efficient relay through the network.
- A Packet Radio Operator utilising a BBS should ensure that all messages transmitted are addressed to the appropriate group of recipients and not addressed to inappropriate areas in order to ensure network efficiency.

### 1.7.2 Guidelines for Packet Radio Bulletin Board Operators

- The Operator of a Packet Radio Bulletin Board is obliged to provide a reliable service, within a defined area for a defined purpose.
- A Packet Radio Bulletin Board Operator is morally responsible for all messages forwarded by his system. He should make his best efforts to ensure that the traffic forwarded is appropriate to the Amateur Services and in accordance with the Guidelines for Packet Radio Operators.
- HF Mail Boxes should only be used where there is a genuine need that cannot be provided by VHF and other means.
- A Packet Radio Bulletin Board Operator may take action to exclude a User who persistently contravenes the Guidelines for Packet Radio Operators. Exclusion of a User should be done as a last resort after the User has been warned and where exclusion does not contravene local regulations.

### 1.7.3 Guidelines for APRS

Based on Cavtat 2008 recommendation CT08\_C5\_Rec13, IARU Region-1 is to adopt the APRS "New n-N Paradigm", as published by WB4APR

By simplifying the network to only accept "WIDEn-N", and telling users to limit their "N's" to the minimum needed for their own area, a vast improvement in reliability and throughput will be achieved in a common IARU, Region 1 APRS System, and beyond.

ON6TI is to draw up a form of words that will detail this further in a future edition of the VHF Managers' Handbook

## 2 AMATEUR SATELLITES

### 2.1 Introduction

The Amateur Satellite Service is a radiocommunications service using spaceborne radio equipment for the same purposes as the Amateur Service. This includes amateur communications by earth orbiting satellites, interplanetary missions and contacts with astronauts on the International Space Station.

Starting with the launch of Oscar-1 in 1961, amateur satellites have become increasingly sophisticated. They have provided voice and data links, served school science groups, provided emergency communications, acted as technology demonstrators, and transmitted Earth images. Construction and operation of any amateur satellite is subject to a range of ITU, IARU and other regulatory and coordination procedures.

### 2.2 IARU Region 1 and IARU Satellite Coordination

#### 2.2.1 General

Satellite builders should make certain that their operating frequencies are coordinated to ensure that mutual interference between different spacecraft does not occur. More information about this process can be found here: <http://www.iaru.org/satellite/>

National VHF/Microwave Managers and Amsat organisations are encouraged to closely coordinate activities and monitor developments in their countries so that, for example, Cubesat projects are fully coordinated. Advice is available from IARU Satellite Advisors and Coordinators.

#### 2.2.2 Satellites transmitting on Amateur bands with undocumented protocols or without permission

There is an ever-increasing number of small satellites being launched these days. Many of these resort to the Amateur satellite service as an inexpensive way of obtaining spectrum access. This is currently generating two problems: some of these satellites have not obtained IARU frequency coordination or other necessary permits but still transmit on the Amateur bands, others obtain IARU coordination but do not publish the specifications of the protocols they use, so Amateurs all over the world cannot decode the satellite signal.

The interim meeting in Vienna propose the formation of a working group within IARU R1 to decide what changes to the IARU frequency coordination process would guarantee that interested Amateurs have enough technical information to make a decoder software.

Since the problems addressed in this proposal are not specific to IARU R1, but rather affect the worldwide Amateur collective, another task of this working group will be to coordinate with the other IARU regions, so that this matter can be treated in a global basis and a joint effort can be made.

Finally, one other task of the working group should be to inform universities through their national societies of the concerns and rules for Amateur bands use and to organize a prospective survey of potential satellite projects to help spread the information.

*Note from EC: The proposal addresses small satellites operating in bands allocated to the amateur satellite service without IARU coordination and encrypted downlink signals in violation of article 25 of the ITU Radio Regulations. This item will be addressed by the IARU Satellite Advisor and the IARU Satellite Frequency Coordination Panel*

### **2.3 Amateur Satellite Names**

Amateur Satellites are currently named within two generic groups, one is OSCAR which is an acronym for Orbiting Satellite Carrying Amateur Radio and the other is RS which is an acronym for Radio Sport, the description used for Amateur Radio in the former Soviet Union.

A nomenclature has been developed that includes a reference to either the group that built the satellite or a name that the builders would like assigned to their satellite e.g. UoSAT-OSCAR -22 that was built by the University of Surrey and Fuji-OSCAR -20 which was built in Japan. For simplicity most Amateur Satellite names are abbreviated to XX-yy e.g. UoSAT-OSCAR-22 is known as UO-22 and Fuji-OSCAR-20 is known as FO-20. Most of the Russian-built Amateur Satellites are simply known as RS-yy.

The OSCAR designation is administered by Amsat-NA not IARU. There is no requirement for an OSCAR number to be assigned to an amateur satellite in order for it to be legitimately recognised and used in the amateur satellite service. However OSCAR numbers are a proud tradition of amateur radio that should be supported and continued.



## 2.4 Amateur-satellite operating practice

(Adopted at the IARU Region I Conference in Warsaw, 1975)

Region I member societies accept the instructions published by the sponsors of amateur -satellites like e.g. AMSAT as regards the times for operation, output powers that may be employed and the way of operating through the amateur-satellite, including adherence to the published satellite bandplan.

All possible publicity should be given to satellite bandplans, operating schedules, power limitations on ground stations etc., together with advice on the necessity of receiver improvement via low-noise pre-amplifiers and, where applicable, low-angle antennas, in order to enable operators to monitor their own and other downlink transmissions satisfactorily, thus ensuring that:

- no transmission is started on a frequency already in use
- interference due to doppler effect frequency shift is avoided
- blocking caused by own transmissions can be identified and output power can be reduced
- other stations calling can be heard and identified.

Amateur-satellite users should be encouraged to:

- refrain from transmitting unless they can monitor their own signals
- strictly adhere to the satellite bandplan with their modes of transmission
- avoid long calls and slow operation
- refrain from operating during times reserved for specific purposes like scientific experiments, as published by the satellite sponsors.

National societies should supervise the implementation of the above recommendations, and take appropriate action against persistent offenders.

The above recommendations were re-confirmed and strengthened at the IARU Region I Conference in Miskolc-Tapolca (1978), where the following resolution was adopted:

***Publicity, preferably on an annual basis, should be given to the correct ethics and practices for satellite operation. National societies should investigate the possibility of setting up monitoring stations for the amateur-satellite service, in order to be able to take direct action against operators who do not observe the internationally agreed operating rules. It is recommended that national societies***

- Write to offending amateurs in their own country (society members as well as non-society members pointing out the correct behaviour and operating practice expected from them;
- report directly to other member societies any infringements of the established rules occurring in their country.
- 

At the IARU Region 1 Conference in Tel Aviv 1996 it was decided that for a trial period the IARU Region 1 Monitoring System coordinator should not limit his activities to the bands below 30 MHz but take care as well, together with the national monitoring system coordinators and national satellite coordinators, of intruders in the input channels of satellite transponders. This activity might be rather complex as even the 145 MHz band is not exclusively for amateurs in some countries and the other satellite allocations have a secondary status in most countries.

But the **VHF Managers** shall pay a lot of attention to this activity as the growing problem of intruders in satellite inputs is becoming a serious nuisance.

IARU-R1

## **2.5 Amateur Satellite Band Plan Usage**

In IARU Region 1 band plans the following frequency segments are designated for use by satellites:-

- 145.800 - 146.000 MHz (out of the overall 144-146MHz ITU allocation)
- 435.000 - 438.000 MHz
- 1260 - 1270 MHz (uplink only)
- 2400 - 2450 MHz
- 3400 - 3410 MHz (only available in a few Region 1 countries)
- 5650 - 5670 MHz (uplink only)
- 5830 - 5850 MHz (downlink only)
- 10.450 - 10.500 GHz
- 24.000 - 24.050 GHz
- 47.000 - 47.200 GHz
- 76.000 - 81.000 GHz
- 134.00 - 136.00 GHz
- 136.00 - 141.00 GHz
- 241.000 - 248.00 GHz
- 248.000 - 250.00 GHz

## 2.6 Satellite Transponder Designations

Apart from beacons and telemetry transmissions, amateur satellites often carry transponders. There are two methods of designating operation modes and frequencies. The original method specified by operational mode type was as per the table below:-

MODE	Uplink between	Downlink between
A	145.8 - 146.0 MHz	29.3 - 29.5 MHz
B	435 - 438 MHz	145.8 - 146.0 MHz
J	145.8 - 146.0 MHz	435 - 438 MHz
K	21.26 - 21.30 MHz	29.40 - 29.50 MHz
L	1260 - 1270 MHz	435 - 438 MHz
S	435 - 438 MHz	2400 - 2450 MHz
T	21.26 - 21.30 MHz	145.8 - 146.0 MHz

More recently a more flexible alternative method has been developed where the input (uplink) is always specified first. A slash is used to separate input and output:-

Band	Wavelength	Designator
21MHz	15m	H
29MHz	10m	T
144MHz	2m	V
435MHz	70cm	U
1260MHz	24cm	L
2400MHz	13cm	S
5650MHz	6cm	C
10GHz	3cm	X
24GHz	1.5cm	K

When this newer method is used for transponder modes, the older designations become:-

Old Name	New Name
A	V/T
B	U/V
J	V/U
K	H/T
KA	H,V/T
KT	H/T,V
L	L/U
S	U/S
T	H/V

IARU-R1

## **2.7 Amateur Satellite Organisations**

For up to date information visit:

<http://www.amsat.org/amsat-new/links/index.php>

<http://www.amsat.org/amsat-new/satellites/>

## **2.8 Current Satellites**

For current operational information check these sites:

<http://www.amsat.org/amsat-new/satellites/status.php>

<http://www.dk3wn.info/satellites.shtml>

<http://oscar.dcarr.org/>

The list is also posted on the RSGB web site at <http://data.dcc.rsgb.org>

## 3 SIGNAL REPORTING SYSTEM

### 3.1 Signal reporting ( Recommendation R.1; R.2)

Although from the beginning of amateur radio signal reports have been essential, no formal standard for the reports exists. But the "Readability, Strength, Tone" system with R,S and T values between 1 and 9 is in widespread use. Several handbooks gave and give in words indications how the values are to be understood.

The readability and tone reports are in principle "subjective" but the strength report can be objective as a simple measurement of the received signal in voltage or power is possible. Such reports are in particular at the VHF and higher frequencies useful for more precise evaluation of propagation, antenna properties and receiver sensitivities.

At the IARU Region 1 Conference in Hungary 1978 the need for a harmonised standard for the "S-meter scale" was expressed and a proposal was accepted for publication in society journals. The essential recommendation was *1 S-point is 6 dB*. At the Brighton Conference in 1981 the recommendation was formally adopted as a standard for amateur radio equipment manufacturers.

At the 1990 Torremolinos conference an amendment was adopted which reconfirmed the -93 dBm reference level for frequencies above 144 MHz, but no statement was issued for the bands between 30 and 144 MHz.

Although not explicitly stated the implication of the recommendation is that on VHF and higher frequencies the S-meter will deviate on the thermal noise only ( S2 in 3 kHz bandwidth, S3 in 12 kHz bandwidth). Although the recommendation is not too complex it seems to be rather difficult to implement by commercial manufacturers.

Another matter is the 'tone' report. This is a subjective measure. It was important in the 'old days' when rather primitive oscillators were used in the TX. Modern transmitters, even on the millimeter bands, have in most cases a very good oscillator, resulting in a 'pure tone' and a T9 report is generally given.

On VHF and higher, however, the characteristics of the propagation medium can significantly 'modulate' the signal (doppler shift, spreading) and a T9 report is not possible. Definitions of tone reports below 9 are rather vague. At the Region 1 conference 1999 in Lillehammer a recommendation (**R.2**) has been accepted to use special letters for signal tone reports when the influence of the propagation is detectable. Such reports can support propagation studies.

#### 3.1.1 IARU Region 1 Technical Recommendation S-METER READINGS

BRIGHTON 1981, TORREMOLINOS 1990

##### *Standardisation of S-meter readings*

- One S-unit corresponds to a signal level difference of 6 dB,
- On the bands below 30 MHz a meter deviation of S-9 corresponds to an available power of -73 dBm from a continuous wave signal generator connected to the receiver input terminals,
- On the bands above 30 MHz this available power shall be -93 dBm,
- The metering system shall be based on quasi-peak detection with an attack time of 10 msec  $\nabla$  2 msec and a decay time constant of at least 500 msec.

### 3.1.2 IARU Region 1 Technical Recommendation TONE REPORTS

Vienna 2010

#### *Tone reports*

In order to give an indication of distorted tonal quality due to special propagation modes, the 1-9 scale of the Tonality (T) component of the RST<sub>I</sub> reporting system will be extended with the following:

- "a" For signals distorted by auroral propagation
- "s" For signals distorted by scatter propagation mechanisms
- "m" for signals distorted by multipath propagation.

For example:-

- 599 - Good signal
- 58a - Fairly good Signal via Aurora
- 59s - Good signal via Scatter (e.g. Rainscatter)

Footnotes

- Other letters may be defined in future should the need arise
- This alternative system may be used for any mode e.g. CW, SSB, MGM etc

### **3.2 The RSQ (Readability Strength Quality) reporting scale for digital modes:**

Where applicable RSQ reporting may be used for digital modes

#### **3.2.1 Readability (% of text)**

- R5 95%+ Perfectly readable
- R4 80% Practically no difficulty, occasional missed characters
- R3 40% Considerable difficulty, many missed characters
- R2 20% Occasional words distinguishable
- R1 0% Undecipherable

#### **3.2.2 Strength**

- S9 Very strong trace
- S7 Strong trace
- S5 Moderate trace
- S3 Weak trace
- S1 Barely perceptible trace

#### **3.2.3 Quality**

- Q9 Clean signal, no visible sidebar pairs
- Q7 One barely visible pair
- Q5 One easily visible pair
- Q3 Multiple visible pairs
- Q1 Splatter over much of the spectrum

**3.3 The MOS (Mean Opinion Score) reporting scale for digitized speech:**

<b>MOS</b>	<b>Quality</b>	<b>Impairment</b>
5	Excellent	Imperceptible
4	Good	Perceptible, but not annoying
3	Fair	Slightly annoying
2	Poor	Annoying
1	Bad	Very annoying
0	Unusable	Total

**Notes:**

Non-integer MOS scores like 3.5 are possible. An MOS of 3.0 is generally referred to as toll quality, meaning good enough to pay for. Digital voice users may tolerate MOS levels less than three if they get additional benefits, such as simultaneous voice and data services.

While evaluation of voice systems may be made based on test-bench measurements, they must ultimately relate to the perception of the listener. A large body of voice-system evaluations exists based on MOS. Comparisons among systems are therefore readily made. MOS relates well to the readability figures commonly used in Amateur Radio signal reports.



## 4 THE LOCATOR SYSTEM

Landshut 2017

### 4.1 Background

The IARU Locator system was defined in 1980 as a World-wide system for radio amateurs to quote their location with sufficient accuracy for practical purposes using a simple alphanumeric scheme related to latitude and longitude. The initial specification called for a 6-character code which could define a station's location to a squaroid<sup>(4)</sup> of approximately 4,6 km each side at mid latitudes. The resulting positional accuracy was therefore around 3 km. This was deemed adequate for VHF contest scoring purposes. For lower resolution, for example at HF, a larger squaroid using just four characters would suffice. Even with six digits, it can prove to be inadequate for microwave usage and thus extensions have come into use.

### 4.2 Updating the Definition of the IARU locator

The widespread use of GPS and the resulting high accuracy possible in specifying any person's location on the Earth has led to a multiplicity of software and applications for radio amateurs such as path profile plots, terrain mapping as well as applications such as Google maps. The IARU locator is a natural contender as a means of specifying any station's position in a format that is much neater and simpler than quoting a latitude / longitude. However, to use the locator in this way means its resolution has to be extended. It is thus opportune to formally clarify that extension and other inconsistencies that have arisen.

### 4.3 Definition of the original IARU locator

Latitude of any station is measured within a range of -90 to +90 degrees, with -90° being the South Pole and +90° being the North Pole. Longitude is defined from -180° to +180° with zero degrees being the Greenwich meridian.

The Locator first divides the latitude/longitude into large 'squaroids' of 10 degrees of latitude and 20 degrees of longitude. There are 18 of these subdivisions for lat and long; each are allocated a letter of the alphabet from A to R.

The first letter of the Locator corresponds to the 20-degree longitude squaroid starting from the antipodal line of +/-180 degrees and counting round the world in units of 20°. Therefore 20 degrees WEST of Greenwich would be the ninth division and gets the letter 'I'

The second character of the locator defines the large squaroid of latitude, counting up from the South Pole up to the North Pole. A latitude of 50 degrees North therefore corresponds to 14 up from the pole and equates to the letter 'O'

Each 20 x 10 degree squaroid is then subdivided into 10, measured conventionally from left to right for longitude and bottom to top for latitude. The pair of numbers from 0 to 9 corresponding to this division are appended to the locator as characters 3 and 4 for long / lat respectively. For example, the squaroid whose lower left corner lies at 2° West and 50° North becomes IO90. This four-character format is the lowest resolution used in practice and at mid latitudes gives a positional accuracy of very roughly 80 km, which is usually sufficient for most HF use.

---

<sup>4</sup> The term 'Squaroid' has been used throughout this document in place of the incorrectly used locator 'square.' The small subdivisions of lat/long are three-dimensional projections on a spheroid and are neither square, nor have their sides straight, nor at right angles. On a Mercator map projection, they may appear rectangular, and at 60 degrees' latitude, may even appear square but this is only an artefact of the projection in use. The term 'squaroid' removes this ambiguity

## IARU-R1

For VHF and up these large squaroids are subdivided into 24 x 24 “sub-squares”, with dimensions 5 x 2.5 minutes of arc for longitude/latitude respectively. Again, counting left to right and bottom to top, they are allocated the letters A to X. For example, IO90IV therefore corresponds to the squaroid whose lower left corner sits at 1 degree 20 minutes West and 50 degrees 52.5 minutes North. This six character format represents a positional accuracy of around 3 km at mid latitudes<sup>5)</sup>

The original 1980 definition also allowed for a further subdivision into 10 “small squares” of 0.5' x 0.25' for roughly 300 metres positioning accuracy. These appear as another pair of numbers, for example IO90IV58. Eight digit locators started to be used amongst some microwave operators in the 1990s for dish bearing calculations where the normal six-digit format was not accurate enough. It also allowed more accurate distance calculations on short microwave paths. Eight characters can also be useful for defining the location of microwave propagation beacons.

### 4.4 Problems with the Existing Scheme

The six or eight-character version only allows positions to be quoted to about 3 km or 300 metres respectively. This can often be insufficient for terrain or path plotting software to work with. When deriving an (approximate) latitude and longitude from a quoted locator we need a reference point within the squaroid to calculate from. This was originally defined as being the middle of the square.

Unfortunately, not everyone has adopted this definition; some software is believed to use the lower left corner. In addition, where locators are quoted to different resolutions, 4, 6 or 8 characters; which ‘middle’ should be used?

Previous to the introduction of the IARU locator, the old QRA used a scheme where its last letter was traditionally spelt in lower case, eg ZM41f. Despite the definition in the VHF Hand-book specifying capital letters, this has carried over into common usage with the ‘new’ six-digit locator. So, people often write IO90iv instead of the original intended IO90IV. The use of lower case for characters 5 and 6 then extended into many popular software packages.

It is also opportune to clarify how the system converges to a single point at the North and South Poles.

### 4.5 New Higher Resolutions

The advent of very high accuracy positioning using GPS and high resolution mapping such as Google Maps has led to an expansion of the use of the Locator scheme. But such expansion has not always been implemented in a coordinated manner.

The majority of schemes in use subdivide the 8 character squaroid into 24 further ‘micro-squares’ each of 0,5/24 and 0,25/24 minutes of arc (1,25 x 0,625 seconds of arc) and append these as another pair of letters, A-X, to make a 10-digit locator; for example, IO90IV58AH. The resulting accuracy of a position so-defined is now about 13 metres.

Several manufacturers of GPS handhelds have used IARU locator as a display option. Several software packages, many interfacing to Google maps, also adopt the 10 character locators. All software packages that have been verified so far use the sub-divisions described above.

However, at least one manufacturer of GPS receivers that have IARU locator as a display option has used a 25 x 25 division with letters A-Y for the final pair (possibly to gain a squaroid of 0,02 x 0,01 minutes of arc). Some have also added a yet another pair of numbers, for 1 metre accuracy.

---

<sup>5</sup> The system converges to a point at the geographic poles. The origin at the South pole is therefore AA00AA00AA. The squaroids at the North and South Poles locations are of zero “width” as the longitude lines have all converged there

## 4.6 Mapping and Accuracy

At one time, every country had its own mapping of latitude/longitude due to adopting a localised spheroid model of the Earth's shape. For example, the mainland UK adopted the GBR36 spheroid. This typically leads to errors of a few hundreds of metres when compared with a lat/long mapping extended from another country. The few-kilometres accuracy of the original six-character locator meant that whatever local mapping was in use, any such error would go unnoticed.

However, the GPS system needs a uniform mapping so the world-wide WGS84 standard has now been adopted as an international standard. To make use of higher resolution locators on a world-wide basis, a similar universal spheroid has to be used for all stations.

## 4.7 Proposals to Clarify and Standardise the IARU Locator, including higher Accuracy positioning

- The definition of the existing 8-character scheme should be extended by adding a further division into 24 lettered squares to give a 10-character locator allowing a positioning accuracy of around 13 metres. Even higher resolution use for future applications should be defined by successively subdividing in the same way; alternating 10 and 24 subdivisions using numbers and letter pairs.
- When the locator is specified at lower resolutions, e.g. 6 characters such as in VHF contests, the centre of the squaroid at that resolution should be taken. This is equivalent to, for example, appending the 6-digit location IO90IV with the mid-range characters 44LL to give IO90IV44LL for the purposes of calculation. A quoted locator of IO90IV58 would have "LL" appended for the calculation.
- That the WGS84 worldwide spheroid be the standard mapping be used for all locator conversions.
- IARU Locators should always be quoted and used employing all Upper Case (Capital) letters.

## 5 ANTENNA POLARISATION ( RECOMMENDATION P.1.)

At several conferences the antenna polarisation has been discussed. Interestingly enough the use of horizontal polarisation, almost exclusively used for non-channelised amateur traffic on VHF and higher frequencies has never been formally recommended. Part of recommendation FM.2. recommends vertical polarisation for FM repeaters.

At the Lausanne conference in 1953 (this is really the oldest technical recommendation of Region 1 ) the helical antenna thread direction was laid down. Why that was done at the time is unclear, but 30 years later (Cefalu 1984 ) the EME community felt a need for the definition of circular polarisation for EME contacts. 12 years later, however, it was recommended to use for EME above 3 GHz linear polarisation for the time being.

As using circular polarisation appears to have advantages for repeater stations the matter may come up again at future conferences.

### 5.1 IARU-R1 1 Technical Recommendation (Signal Polarisation)

LAUSANNE 1953, CEFALU 1984, TEL AVIV 1996

#### 5.1.1 Standards for signal polarisation

- **Helical aerials**  
Looking into the direction of transmission, helical beam aerials shall have a right-hand thread.
- **Moonbounce aerials**  
The polarisation of microwave signals used for communication via moonbounce shall be right-hand circular, i.e. the wave travelling away from the observer should rotate in a clockwise direction for operation below 3 GHz.  
For operation above 3 GHz linear polarisation shall be used. European stations should use vertical polarisation. All stations shall include provision for adjustable polarisation and be prepared to agree the offset beforehand. Exact polarisation offsets shall be checked at the commencement of activity. Should technical developments occur to make circular polarisation practical for general adoption this will be considered at a future conference.
- **FM Repeater aerials**  
Vertical ( see recommendation FM.2.)

## 6 DEFINITION FOR PING AND BURST FOR SCIENTIFIC ANALYSIS OF AMATEUR RADIO METEOR SCATTER

For the analysis of scientific data the old way of defining a ping and a burst, which depended on information / no information, is not relevant.

### 6.1 Definitions

- **Ping:** Reflection from an underdense meteor trail.
- **Burst:** Reflection from an overdense meteor trail.

### 6.2 Background:

Radio Amateurs have used the term "ping" to describe a 'short' reflection. Most of the European operators define "ping" as a reflection too short to pass information. This definition was most likely evolved in the 1970's, when high speed CW (then < 600 LPM) gained popularity in Europe. With the less efficient equipment used those days, the shorter reflections were either too short to pass full characters due to slow speed and/or too weak to decode with the equipment available at that time.

Some operators define "ping" as a reflection from an underdense meteor trail and "burst" as a reflection from an overdense trail. This is also how 'ping' and 'burst' are described in The VHF/UHF DX Book (published by RSGB). Generally it can be said that most good reflections come from overdense trails and short/less usable reflections (pings) from underdense trails. Overdense and underdense reflections can be roughly separated by duration of the reflection (reference 1).

The principal difference of underdense and overdense trail is the mechanism that re-emits RF-energy. On underdense trails the RF-energy penetrates the trail and makes electrons oscillate and re-radiate energy, while on overdense trails, no penetration occurs and the trail is modelled as a metallic cylinder reflecting RF-energy. When receiving meteor reflections the audible differences are found in signal strength, duration and decaying shape.

CW speeds used in MS have increased since 1970's by about four times and new digital equipment (i.e. DTR) make copying useful information from a weak reflection now much more easier. The old way of defining a ping has thus become invalid and does have serious lack of logic by definition, while the underdense/overdense division is based on well-known and studied physical facts, as described in scientific literature.

It would also be extremely useful, if MS working results published i.e. in DUBUS were of scientific use. Such working results could be used by people like OH5IY, who are doing scientific research on meteor scatter. QSO information in DUBUS contains the number of pings and bursts of every contact. This information is of little use, however, if ping is understood as a reflection with no information, thus depending on speed used. Instead, if ping is defined as an underdense reflection this kind of information would be of great value. The relative number of underdense and overdense reflections could be compared between different showers and between consecutive hours in the same shower. This would provide us new knowledge of meteor showers and sporadic meteors.

### 6.3 Aid for defining underdense and overdense trails

Underdense and overdense reflections can be roughly separated by duration of the reflection (which varies by frequency). The threshold is not sharp, but a simple approximation can be made. On 50 MHz overdense trail durations are typically greater than 0.5 s (reference 1) and maximum underdense trail durations approximately 0.5-1 s (reference 2).

In the following table a 1 s reflection on 50 MHz has been taken as upper limit for the underdense trails. <sup>3)</sup>

Durations for other frequencies have been derived from it according to the following formula (reference

Where  $t$  = duration in seconds,

$f$  = frequency in MHz

#### 6.3.1 Maximum duration of an underdense reflection (ping):

<i>Frequency</i>	<i>Duration</i>	<i>CW speed</i>	<i>Number of letters received</i>
<b>50 MHz</b>	1 s	100 LPM	2
		1000 LPM	17
		2000 LPM	33
<b>70 MHz</b>	0.5 s	100 LPM	1
		1000 LPM	8
		2000 LPM	17
<b>145 MHz</b>	0.1 s	100 LPM	0
		1000 LPM	2
		2000 LPM	4
<b>435 MHz</b>	0.013 s	100 LPM	0
		1000 LPM	0
		2000 LPM	0

This table corresponds well with the situation as presently encountered on the popular 144 MHz band. For example, a reflection on 145 MHz with the speed of 1000 LPM containing up to two letters when decoded would be a ping. On the 435 MHz band pings are so short in duration (less than 0.013s) as to be almost impossible to detect.

#### 6.3.2 References:

1. The evolution of meteor burst communications system, P.S. Cannon & A.P.C Reed, Journal of the Institution of Electronic and Radio Engineers, Vol. 57. No. 3, pp 101-112, May/June 1987.
2. J.A.Weitzen & al., An Estimate of the Capacity of the Meteor Burst Channel, IEEE Transactions on Communications, Vol.Com-32, No.8. August 1984.
3. W.T. Ralston & al. Distribution of underdense meteor trail durations and duty cycle and applications to meteor scatter communication system design. Radio Science, Volume 28, Number 5, pp 747-757, September-October 1993

## 7 FREQUENCY MODULATED TELEPHONY

### 7.1 The basic FM standard (Recommendation FM.1.)

One of the longest standing IARU Region 1 technical recommendations, adopted at the Region 1 Conference in Brussels (1969) deals with the basic parameters of Narrow Band FM (NBFM) Telephony. It states *"For FM within Region 1 a maximum modulation index of 1 and an audio band restricted to 3 kHz shall be used"*

Between 1963 and 1969 the gradual introduction of VFO controlled SSB, replacing AM(x-tal controlled), was taking place on VHF. At the same time, however, the problems with LF break-through in radio, TV and audio equipment became embarrassing. Using FM and PM appeared to be the right solution in this case. Of course the recently acquired habit of VFO control and co-channel working was used with FM as well.

In order for an efficient use of FM it appeared necessary to agree upon a few basic parameters which would determine the optimum filter to be used in the receiver. A 12 kHz receiver bandwidth was finally chosen. This appeared to be the minimum value giving distinctly better quality than 6 kHz AM without showing too much of a threshold effect (at least not much more than conventional AM). Soon after the recommendation had been adopted several manufacturers of crystal-filters marketed 12 kHz wide filters.

Almost 30 years later this basic recommendation still is in force, although VFO controlled FM has almost disappeared (it still is used with rain-scatter on microwaves) and the majority of amateurs use crystal-controlled FM transceivers with filters wider than 12 kHz, thus losing several dB's in communications efficiency.

It must be noted that the application of the recommendation is not limited to frequencies above 30 MHz. It equally well applies to the 29 MHz band, although it appears that FM on that band is often received with filters narrower than 12 kHz.

Three years later, at the 1972 Scheveningen conference, a more detailed standard, largely based upon the first was adapted, but this time VFO control appeared to be out of fashion and the standard dealt with "Fixed channel FM stations". The audio response was specified more in detail as *300-3000 Hz with a 12 dB/octave fall off outside this band and 6 dB/octave pre-emphasis.*

It appears sensible to combine those two recommendations into a single one at a future conference.

#### 7.1.1 IARU Region 1 Technical Recommendation FM.1

BRUSSELS 1969, SCHEVENINGEN 1972

- **TECHNICAL STANDARD FOR NARROW BAND FM (NBFM)**
  1. For FM within Region 1 a Maximum Modulation Index of 1 and an audio band restricted to 3 kHz shall be used.
- **TECHNICAL STANDARDS FOR FIXED CHANNEL FM STATIONS**
  1. Traffic mode: Simplex on one channel.
  2. Maximum Deviation:  $\nabla$  3 kHz, 12K0F3E.
  3. AF response: 300 - 3000 Hz, outside this band down with 12 dB/octave.
  4. Pre-emphasis: +6 dB/octave in the transmitter.
  5. De-emphasis: -6 dB/octave in the receiver.

## 7.2 FM Repeaters ( Recommendation FM.2.)

At the 1972 Conference in Scheveningen a recommendation was worded for the then appearing FM repeaters. Initially the recommendation only was meant for the 145 MHz band, but later the 435 MHz band was added. The recommendation -of course- was based upon the standing recommendation for the audio channel parameters ( FM.1.). But in addition the antenna polarisation was recommended as being *vertical* **which was a logical choice for a system meant to be used by mobile stations. Note that, although no** recommendation on antenna polarisation existed at the time, consensus existed on the use of horizontal polarisation for all VHF and UHF activities and that still is the case for all non-channelised activities on VHF/UHF.

In order to make the planning of repeaters using the same channel easier a *maximum ERP of 15 Watts* was recommended. As, however, the antenna height above the surroundings was not specified this ERP limit is not sufficient for the planning, but no additions have been made to this recommendation. The major flaw of the recommendation is the lack of any explicit specification of the receiver bandwidth. Had the receiver parameters been defined compatible with the transmitter definition (some people think this is implicit) some difficulties in a few countries with the introduction of a 12.5 kHz channel spacing system would never have been arisen.

### 7.2.1 IARU Region 1 Technical Recommendation FM.24

#### *Technical standards for FM repeaters in the 145 MHz and 435 MHz bands*

- **Polarisation:** Antennas in the repeater service shall have vertical polarisation.
- **Operation:** Repeaters should use either CTCSS or 1 750 Hz tone burst for access in order to prevent unwanted operation caused by interference or other signals. CTCSS is preferred for new FM repeaters - see below. DTMF can be optionally used to control repeater functions as per below. When the signal to be relayed has disappeared or the operating time has come to an end the repeater station shall send its own call, and 15 seconds thereafter the transmission shall be interrupted. It should not be possible to interrupt the automatic identification transmission by a selective call. For the station identification F2A modulation shall be used.  
When working through a repeater station the lowest usable power consistent with good communication is recommended.
- **Power:** The effective radiated power of the repeater transmitter shall not exceed 15 Watts.
- **Traffic mode:** Simplex using demodulation/remodulation on a single channel / frequency pair.
- **Deviation:** The maximum deviation of the repeater transmitter shall be  $\nabla$  3 kHz ( 12K0F3E).
- **A.F. response:** Audio frequency response shall be 300 - 3000 Hz. Outside this band the response shall go down with 12 dB/octave.
- **Pre-emphasis:** The transmitter pre-emphasis shall be +6 dB/octave.
- **De-emphasis:** The receiver de-emphasis shall be -6 dB/octave.
- **Responsibility:** The repeater shall be under the control of the national IARU member society or their agent. The member society shall be responsible for the allocation of the adopted channel frequencies.
- **CTCSS:** The use of CTCSS is strongly encouraged for VHF and UHF FM repeaters in Region 1, with the aim of reducing inadvertent interference by users to repeaters sharing the same input channel. In order to minimise mutual unwanted interference, from 1 Jan 2015 all new FM repeaters should use CTCSS tones on receivers as well as on transmitters.



IARU-R1

For CTCSS the frequencies listed in table FM2.1 shall be adopted as a standard so that compatibility between repeater systems in different countries can be maintained, aiding the traveller who moves between countries.(The frequencies shall be accurate  $\nabla$  1%)

- **DTMF:** The DTMF system as specified below can be used as an alternative to the control of repeaters, voice mail boxes etc.
  - The hardware part of the DTMF system consists of a keyboard with 12 push-buttons using the symbols #,\* ,A,B,C,D and figures from 0 to 9. When pressed each push-button will activate 2 tones simultaneously, one above, the other below 1000 Hz, according to the following scheme in table FM.2.2.
  - For example, if No. 5 is pressed, the tone combination 770 Hz/1336 Hz will be the result. The tone frequencies have to be accurate within  $\nabla$  1.5 % .
  - Each tone burst should be between 65 and 105 msec long. The pause between tones should be at least 200 msec.

- **User functions:** To control the basic functions of repeaters and voice-mailboxes, the following codes should be used :

Basic commands :

- 6. \* Repeater opens, ( like the 1750 Hz )
- 7. \* + 0 Repeater opens and transmits callsign, location and - if necessary- the CTCSS tone.
- 8. \* + 1..9 Additional functions ( squelch control, power level and others )

These basic commands can be extended and it is possible to control special functions of the repeaters or voice-mailboxes

**7.2.2 CTCSS frequencies Hz to be used for repeater access**

CTCSS FREQUENCIES IN Hz TO BE USED FOR REPEATER ACCESS			
67,0	94.8	131.8	186.2
71.9	100.0	141.3	203.5
74.4	103.5	146.2	210.7
77.0	107.2	151.4	218.1
79.7	110.9	156.7	225.7
82.5	114.8	162.2	233.6
85.4	118.8	167.9	241.8
88.5	123.0	173.8	250.3
91.5	127.3	179.9	

**7.2.3 DTMF frequency pairs**

<b>DTMF FREQUENCY PAIRS</b>				
<b>Hz</b>	<b>1209</b>	<b>1336</b>	<b>1477</b>	<b>1633</b>
<b>697</b>	<b>1</b>	<b>2</b>	<b>3</b>	<b>4</b>
<b>770</b>	<b>4</b>	<b>5</b>	<b>6</b>	<b>B</b>
<b>852</b>	<b>7</b>	<b>8</b>	<b>9</b>	<b>C</b>
<b>941</b>	<b>*</b>	<b>0</b>	<b>#</b>	<b>D</b>

## 8 DIGITAL TRANSMISSIONS

### 8.1 Principles for digital modes

The increase in digital modes, their rate of change, innovative developments and on air activity should be considered in a more strategic and less prescriptive manner.

There has been a trend by both IARU and national regulators to be 'Technology Neutral', particularly for high-level recommendations, to ensure they do not specify a particular mode. Indeed, IARU Region-1 C5 has led this by using general terms such as MGM or DV.

The increase in digital modes should be facilitated where possible by reviewing and relaxing Bandwidth restrictions that may have their origins in classical analogue modes (CW, SSB etc) – and may now impede new data modes.

The use of computing/automation can however undermine the criteria for valid QSOs for Contests, Awards etc. The IARU-R1 QSO definition should still be respected.

Therefore the interim meeting in Vienna 2019 adopted following principles:

- **Mode Neutrality:** The Band Plans in the VHF Managers Handbook shall remain Mode-Neutral as far as possible including for MGM, Digital Voice(DV), Digital Data (DD) and DATV, avoiding frequency designations for specific digital modes
- Whilst the IARU Band Plans should adhere to the 'Mode Neutrality' principle above, Member Societies remain free at national level to **coordinate specific mode designations**
- **Bandwidth** restrictions should be reviewed and relaxed where possible to facilitate experimental and emerging digital communications modes (but the need to be mode-neutral should still be observed)
- **Digital Developers** should be encouraged to avoid embedding or recommending spot frequencies, and instead to **consult IARU band planners** and incorporate flexibility
- **Valid QSOs** for contests and awards etc shall respect the IARU-R1 QSO definition and in particular the criteria that **the human operator is responsible**. This requires that such contacts are not invalidated by the use of automation – such as auto-completion, databases etc.

### 8.2 Packet-radio (mailbox) operating practice

At the IARU Region 1 Conference in Torremolinos (1990) the following recommendation was adopted:

*The Conference endorses the views expressed in documents 90/TS/C3.50 and 90/TS/C.53 on the undesirability of spreading of inappropriate messages via Packet-Radio Bulletin Board Systems and would extend this view to any use of the amateur bands which contravenes the definitions of the Amateur Service and Amateur Satellite Service.*

You will find document 90/TS/C3.53 contained the IARU Administrative Council Resolution 87-2 (revised in 1989) in chapter 6.6.

Document 90/TS/C3.50 was a paper submitted by ARI, which with regard to messages having inappropriate content in essence expressed the same views as AC Resolution 87-2.

At its meeting in Bandung, October 1991, the IARU Administrative Council re-considered the matter of inappropriate traffic via Packet Radio, and drafted an additional Resolution 91-1. At its meeting in Vienna, March 1992, the IARU Region 1 VHF/UHF/Microwaves Committee decided to recommend the immediate introduction of this Resolution as interim Region 1 policy. This was accepted by the IARU Region 1 Executive Council at its meeting in Budapest, April 1992, and later ratified by the IARU Region 1 Conference in De Haan (1993). The AC Resolution 91-1 is attached as chapter 6.7.

IARU-R1

### **8.3 Concerning the relaying of messages to amateur stations**

RESOLUTION 87 2 (Revised 1989)

The IARU Administrative Council, Noordwijkerhout, April 1987:

*Recognising the problems caused by the handling by amateur stations of communications having inappropriate content, particularly with regard to business and commercial matters*

*Recognising the impact on other users of the crowded spectrum from unattended store and forward ("mailbox") stations, and further recognising that the problem of controlling the content of amateur radiocommunication is made more difficult by the availability of such stations,*

*Resolves that the Administrative Council affirms the action taken at its Buenos Aires meeting, in urging member societies to emphasize to their members the importance of adhering to the spirit and intentions of the ITU Radio Regulations, and of handling only that traffic which does conform; and further*

*Resolves that member societies are hereby urged to acquaint their members as to the undesirable aspects of the uncontrolled proliferation of unattended store and forward ("mailbox") stations.*

IARU-R1

## **8.4 Concerning guidelines for packet radio**

RESOLUTION 91-2

The IARU Administrative Council, Bandung, October 1991,

*Considering the growing popularity of packet radio for the relaying of messages between radio amateurs,*

*Recognizing that a medium as effective as packet radio can invite abuse through the introduction of traffic that is inappropriate to the Amateur Service internationally,*

*Noting Resolution 87-2 (revised 1989) which urges adherence to the spirit and intentions of the ITU Radio Regulations in handling traffic, and calls attention to the undesirable aspects of the uncontrolled proliferation of unattended store-and-forward "mailbox" stations,*

*Resolves that the attached "Guidelines for Packet Radio Operators" and "Guidelines for Packet Radio Bulletin Board Operators" first adopted at the Region 3 Conference, Bandung, October 1991, shall be distributed to IARU member-societies worldwide with the request that they be shared with the amateurs of each country, and*

*further resolves that future IARU regional conferences are invited to suggest improvements to these guidelines so they will continue to be representative of good amateur radio operating practices as these practices evolve over time.*

IARU-R1

## **8.5 IPv6 allocation**

Varna 2014

The IARU Region-1 VHF/Microwave Committee (C5) recommends that in order to underpin an exciting future for amateur data communications that the IARU Administrative Council considers the draft paper from Region 1 and provides support for obtaining an IPv6 allocation for global amateur radio.

IARU-R1

## 8.6 Digital voice

ÖVSV will start activities for gaining interoperability in bridging technology for Digital Voice modes.

## **9 AMATEUR ( WIDE BAND ) TELEVISION**

### **9.1 Vestigial Sideband AM ( Recommendation V.1.1.)**

After some initial experiments with fast-scan TV transmission in the 145 MHz band around 1955/60 the wider 435 MHz band seemed ideal for fast-scan broadcast quality ATV experiments. Although in several Region 1 countries the parameters were set by the national administration, IARU Region 1 at its 1969 Conference in Brussels recommended "*CCIR-2, following the Gerber standard*".

At a later conference (Warsaw 1975 ) it was recommended to use "*vestigial sideband techniques in the 435 MHz band*" and at the same time "medium band ATV or SATV" was brought forward in order to "conserve bandwidth" in the 435 MHz band. This aspect was important as in several countries in Region 1 amateurs could only use part of the 430-440 MHz band.

The 1987 Noordwijkerhout conference recommended that Vestigial Sideband *ATV in the 435 MHz band should use the 434-440 MHz segment with the carrier frequency either below 434.5 or above 438.5 MHz*. This, in fact, determined the maximum allowed bandwidth of the modulated signal.

### **9.2 Medium bandwidth ATV ( Recommendation V.1.2.)**

As in several countries only 6 MHz of the 435 MHz band is allocated, the "normal" ATV transmission is not possible. As an alternative the relatively narrow-band system proposed by DC6MR has been recommended as an alternative.

### **9.3 FM-ATV (Recommendation V.2. )**

For ATV experiments above 1 GHz a recommendation was adopted at the 1991 Torremolinos Conference. The recommendation was based upon the emerging standards for satellite TV transmitters, but as in many of the microwave amateur bands the available spectrum was limited, a *channel bandwidth of 18 MHz (-60 dB)* was recommended. Although the standard was adopted without much discussion, at the 1996 Tel Aviv conference it was decided that it was not possible to adhere to the given bandwidth limitation when complying with all other parts of the recommendation. This was due to the recommended audio sub-carriers at 5.5 or 6 MHz .

At the Lillehammer 1999 Conference the standard was amended in the shared microwave bands. Although the level of the spectrum outside the main spectral lobe is not yet ideal, the standard is now more realistic.



## 9.4 IARU Region 1 technical recommendations concerning ATV

WARSAW1975

### 9.4.1 IARU Region 1 Technical Recommendation BASIC FAST SCAN AMATEUR TV STANDARD

- The standard transmission system for Amateur Television shall be the CCIR-2 system following the Gerber standard.
- The use of vestigial sideband techniques should be encouraged for use in the 435 MHz band.
- ATV in the 435 MHz band should use the 434-440 MHz segment with the carrier frequency either below 434.5 MHz or above 438.5 MHz.

### 9.4.2 IARU REGION 1 TECHNICAL RECOMMENDATION SATV

#### SATV - A SECOND TECHNICAL STANDARD FOR ATV

The technical parameters of SATV (small-bandwidth ATV) are as follows:

- Picture frequency and line frequency as for the CCIR-2 system.
- Maximum video bandwidth between 500 kHz and 1 MHz.
- No audio carrier; the audio information is FM modulated on the video carrier, maximum deviation  $\nabla 5$  kHz.

#### Note:

SATV transmitters are very easy to construct : no audio transmission is required and the tuning of the PA stages is simple.

At the receiving end there are two possible concepts:

- The bandwidth of the TV receiver is made smaller and an I.F. limiter plus an FM detector are added.
- A normal FM receiver is used for the audio part of the signal. From between the mixer and the I.F. filter of this receiver the broadband signal is coupled to a separate I.F. amplifier and detector, and the video signal obtained is sent to a video monitor.

Modern TV receivers can be easily modified for SATV.

#### Note:

Advantages: Better use of the bands - e.g. several simultaneous QSO's possible in the bandwidth available in the 435 MHz band - and better signal range.

### 9.4.3 IARU Region 1 Technical Recommendation V.3

MISKOLC-TAPOLCA 1978

#### Facsimile standards

For facsimile transmissions in the Amateur Service the following characteristic values are preferred:

- The video (picture) modulated signal is generated at the audio frequency level, similar to the technique used for SSTV. The edge frequencies for "black" and "white" are 1500 Hz and 2300 Hz respectively; the frequencies corresponding to the half-tones are between these two frequencies. The audio frequency bandwidth is maximally 3000 Hz.
- The rotation speed of the picture drum is switchable between 60, 90, 120, 150, 180 and 240 rpm, with 60, 120, 180 and 240 rpm being the preferred values.
- The index of co-operation shall provisionally be 288, in accordance with CCIR recommendation. Minor deviations from this value are permissible.
- Phasing-in signals and end-of-picture signals will be chosen at a later stage, taking into account practical considerations based on the state-of-the-art.

IARU-R1

- All Amateur Service allocations should be open for this mode of transmission. Operation via repeaters and amateur satellites should also be allowed.
- For the transmissions F1C should be used. ( e.g. frequency shift keying of an audio frequency sub-carrier, which modulates the main carrier in SSB, or direct FSK (shift-keying) of the main carrier by the modulating signal). Additionally, on frequencies above 144.5 MHz mode F2C, i.e. FM/AFSK modulation of the RF carrier by a frequency-modulated sub-carrier, is permitted.

**9.4.4 IARU Region 1 Technical Recommendation V.2 for Microwave ATV**

LILLEHAMMER1999,TORREMOLINOS 1991

<b>STANDARDS FOR MICROWAVE FM ATV</b>		
	<b>&gt; 1 GHz - &lt;24 GHz</b>	<b>&gt; 24 GHz</b>
<b>Mode of emission</b>	F5/F3	F5/F3
<b>Video bandwidth (3dB)</b>	5 MHz	5 MHz
<b>Pre -emphasis</b>	CCIR rec 405.1	CCIR Rec 405.1
<b>Colour sub carrier frequency</b>	4.433618 MHz	4.433618 MHz
<b>Maximum instant mod. index</b>	-	.05
<b>Peak dev.(with pre-emphasis)</b>	3.5 MHz	3.5 MHz
<b>Channel bandwidth</b>	12 MHz at -40 dB 18 MHz at -50 db	12 MHz at -40 dB
<b>Sound sub-carrier frequency</b>	5.5 MHz	5.5 or 6 MHz
<b>Sound sub-carrier amplitude (with respect to peak video)</b>	-	-14 dB
<b>Sound sub-carrier modulations index</b>	0.07	0.2

**Notes**

- A video filter having a -3 dB bandwidth of 5 MHz should be included in the modulating amplifier.
- A video peak clipper should be included after the pre-emphasis but before the video filter.
- DC clamping of the video signal should be included to prevent the nominal carrier frequency from changing with different television scenes.
- An RF output filter should be included to prevent out of band energy from whatever source from reaching the aerial system.
- When it is necessary to reduce the transmitted bandwidth on frequencies >24.0 GHz below that shown above the sound carrier should be reduced in level or be removed altogether.

**9.4.5 IARU Region 1 Technical Recommendation for Digital ATV**

DATV is recommended based on the following parameters:

Frequency Band	Symbol Rate (Msymbols/s)	Maximum Bandwidth
435 MHz	2.00	2 MHz
1.3 GHz Repeater i/p & simplex	2.00 or 4.00	4 MHz
1.3 GHz Repeater o/p	4.00	4 MHz
2.3 GHz	4.00	4 MHz
3.4 GHz	2.00	2 MHz
5.6 GHz	4.00	4 MHz
All bands above 5.6 GHz	4.00	4 MHz

**Notes:**

- To facilitate development, other modes and bandwidths may be used where conditions permit.
- The bandwidths in the table above are recommended maximums. Development of narrower bandwidths are strongly encouraged as equipment allows
- DATV operators should ensure they transmit 'clean' signals in order to avoid adjacent channel interference. Particular attention is recommended regarding power amplifier linearity and the transmitted output spectrum
- Other frequency bands are permitted if the bandwidth is compatible. Any ATV operation should avoid interference to narrowband frequency centres in the relevant band plan
- Established and/or open standards, along with a subset of Operating and frequency planning parameters, should be adopted to:
  - Ensure interoperability between DATV operators
  - Ensure compatibility with readily available consumer hardware

## 10 BEACON REQUIREMENTS

### 10.1 Beacon message

As beacons are often heard at very low signal levels, together with spurious signals, it is important the message is simple, unambiguous and repeated frequently. It is also necessary to have a period without information (“carrier”) for frequency checking purposes and signal strength measurement; and also to make it easy to distinguish the frequency when using F1A.

- For a coordinated beacon, the only essential information in the beacon message is the callsign. The locator or other information is not essential
- The callsign should be sent in plain CW at least once per minute, not exceeding 60 characters per minute
- Beacons should include a period of plain carrier of approximately 20-30s, sufficient for frequency checking purposes.
- For mixed mode beacons, the MGM mode should start on the even minute, whilst the odd minute includes the plain carrier period. Effort should be made to ensure good timing accuracy of the even/odd minutes.
- It may be helpful to indicate a forthcoming change of mode by a short CW symbol (such as an ‘S’ or ‘X’)
- For beacons that are MGM only (which should only be exceptions to the other recommendations) then the message should be MGM at the start, followed by the CW ID within a minute period.

Examples of these (with approximate message lengths) are illustrated below:- Simple 30 & 60 second Messages

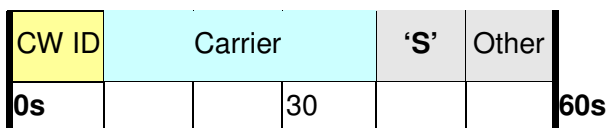
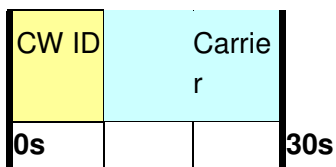

MGM Mixed Mode (these are examples and can be change to suit the MGM mode deployed – Varna 2014)

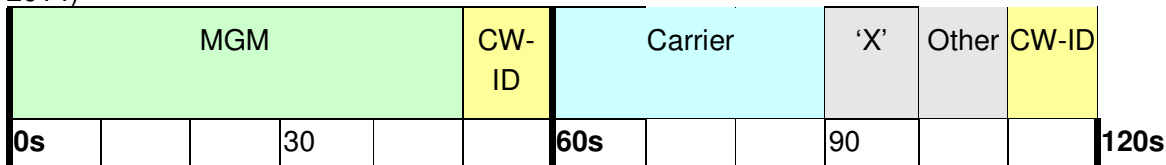

## IARU-R1

### MGM Mixed Mode

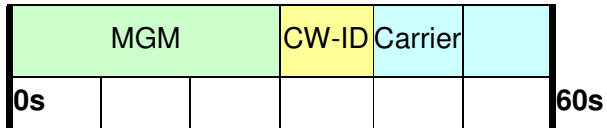

### MGM Mixed Mode

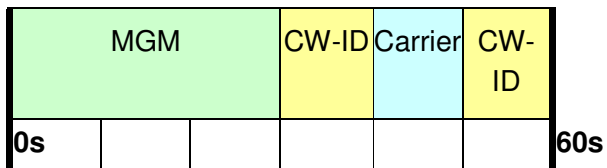

### MGM

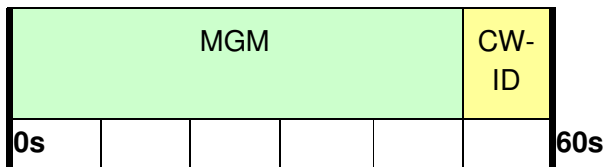

## 10.2 Operation

- Operation should be 24 hour continuous.
- If beacons change parameters during the transmission this must be reflected in the message transmitted.
- IARU Region-1 encourages best practice for both timing/frequency accuracy and phase noise to enhance general performance for the benefit of all.
- That development of new modes optimised for beacons are encouraged, which may either enhance DX reception or permit more efficient equipment (and thus lower electricity costs) to enhance sustainability
- That National Societies and IARU-R1 coordinators be kept updated on such developments.

### 10.3 Beacons spectrum

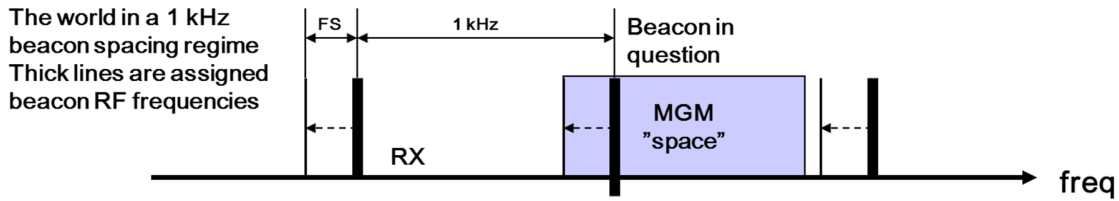

Should MGM be implemented on a beacon, a standard 1kHz tuning offset should be adopted as per the example in the diagram.

In any given frequency band, the specific MGM selection should have regard to the beacon frequency spacing and MGM bandwidth

### 10.4 Status

It is important that the operational parameters and the status of each beacon are widely known. The information should be sent to the IARU Region 1 VHF beacon coordinator via the local beacon

## 11 PROPAGATION RESEARCH BY AMATEURS

### 11.1 Introduction

Amateurs have always contributed to radio science, both in the technical field, e.g. with the development of new transmitting and receiving methods, and in the field of propagation research by showing the limits of distance and the variety of propagation phenomena that can be used over an ever increasing range of frequencies.

Regarding propagation, amateur contributions during the first years of radio in the 'world below 200 metres' are, of course, well-known, as are, for instance, the pioneering efforts of the "amateur" Grote Reber in the field of radio-astronomy. Those were the early days, but also in more recent times amateurs have made considerable contributions in the field of scientific investigations. To mention a few examples:

- in the fifties several research institutes in Western Europe carried out tropo-scatter research in close co-operation with an extensive network of amateur observer stations;
- fundamental work was and is done by amateurs in the definition and study of the TE (Trans-Equatorial) propagation mode of VHF radio-waves;
- during the IGY (International Geophysical Year), amateurs supported various propagation research projects initiated by the Max Planck Institute in Katlenburg/Lindau as well as by other scientific institutes.

The important facts which enable amateurs to make valuable contributions to propagation research are:

- world-wide there are almost no regions which are not covered by amateurs. If effectively organised, amateurs constitute an extensive network of observation points that an official research institute could hardly afford to set up;
- amateurs are enthusiastic in the disciplines they pursue, are often on the bands for extended periods of time - pushing the various propagation modes to their limits! - and in many cases, are in possession of high-performance, individually-calibrated pieces of transmitting/receiving equipment.

IARU Region I fully recognizes the importance of this type of work in the Amateur Service, and at the IARU Region 1 Conference in Warsaw (1975) the following general recommendation was adopted:

- Groups of amateurs shall be organised to carry out scientific observations regarding all forms of radio propagation, including
  1. ionospheric
  2. tropospheric
  3. space.
- These groups are recommended to co-operate closely with RSGB, DARC, REF and any other societies which have a proper organisation for handling scientific data and co-operating with scientific institutes.
- It is also recommended that the results of such observations be published in the journals of member societies and/or scientific journals.

Currently, in the international field, amateurs are involved in long-term studies of tropospheric and auroral propagation modes, long range ionospheric high MUF studies and the study of the characteristics of moonbounce and meteor-scatter techniques.

## IARU-R1

On a national scale amateurs co-operate in the development of repeater systems for mobile station use, together with studies of terrain and inner city problems associated with operating mobile stations.

Furthermore, studies are carried out on the effects of micro (local) climate on space communications and, in particular, on microwave band communications during adverse weather conditions like e.g. heavy rain, which can enhance signals considerably.

The above is certainly not an exhaustive summary; on the contrary, the list of scientific activities in which amateurs participate is expanding all the time.

## 11.2 Coordination of amateur participation in propagation research

As set out in the introduction (section IVa), IARU as well as IARU Region 1 have always recognized the importance of scientific work carried out by amateurs, and IARU Region 1 are officially supporting various activities of member societies in the field of propagation research.

Currently the RSGB, via their RSGB Propagation Studies Committee, and the SARL are the member society which co-ordinate the amateur participation in propagation research.

### 11.2.1 Sporadic-E investigations

At the IARU region 1 Conference in Warsaw (1975) REF proposed to start on two projects:

- a study of long distance VHF propagation with the aid of beacons to be set up in the southern part of Europe
- a study of sporadic-E activity over the North Atlantic area, particularly on the amateur bands 28 MHz and 50 MHz.

Both projects were accepted at the final Plenary Meeting of this Conference, and the work of supervising these projects was entrusted to Serge Canivenc, F8SH, who was nominated as IARU Region 1 Coordinator for sporadic-E investigations.

The following recommendations concerning the above projects were adopted at the IARU Region 1 Conference at Warsaw (1975):

***Sporadic-E investigations: that the proposal to establish beacon stations in southern Europe, as described in document WA58 (with the exception that the radiated power should preferably be limited to 50 W) be adopted. Proposals for beacons should be submitted through member societies to the IARU Region 1 Sporadic-E Coordinator Mr. Serge Canivenc, F8SH.***

Transatlantic Sporadic-E investigations: that the proposals set out in document WA59 be adopted in order to promote an investigation of Sporadic-E propagation in the North Atlantic area. It is also recommended that Region 2 be invited by Region 1 to encourage their member societies to set up, for the purpose of the investigation, beacon stations in the 50 MHz band, e.g. in Canada and in the U.S.A. Region 1 societies should then establish an observation network in consultation with Mr. Serge Canivenc, F8SH, the IARU Region 1 Sporadic-E Coordinator. Region 2 is invited to join the programme and to publicise the contents of document WA59.

On the basis of the above recommendations, F8SH extended his activities and started a programme for the investigation of VHF wave propagation via Field Aligned Irregularities (FAI). This phenomenon was discovered by amateurs in southern Europe in the 70's. They noticed that stations contacted during sporadic-E openings were often on a quite different bearing from the one corresponding to the normal great-circle path.

F8SH fulfilled the function of IARU Region 1 Sporadic-E Coordinator till July 1988 when he suddenly passed away. His excellent work, his many publications and his highly appreciated representation of the Amateur Service in the CCIR Interim Working Party 6/8 dealing with anomalous VHF ionospheric propagation will be remembered with gratitude.



IARU-R1

He was succeeded by **Jim Bacon, G3YLA** ( address in section If) who will continue and further develop the work started by F8SH.

### 11.2.2 Auroral propagation

At the IARU Region I Conference in Warsaw (1975) the RSGB, via their Propagation Studies Committee, proposed to standardize auroral reporting by amateurs throughout Region I, so that the greatest use can be made of these reports for scientific studies.

At the final Plenary Meeting of the Conference this proposal was adopted, and Charlie Newton, G2FKZ, was nominated as IARU Region 1 Coordinator for Auroral Studies.

The following recommendation relating to the auroral project was adopted at the IARU Region 1 Conference in Warsaw (1975):

*VHF Auroral Propagation: that the proposals set out in document WA32 (regarding the standardisation of auroral reporting) be adopted by member societies and that member societies publicise the reporting forms contained therein.*

In 1993 G2FKZ resigned, and the IARU Region 1 Conference in De Haan (September 1993) nominated as his successor **Vaino Lehtoranta, OH2LX** (address in section If)

### 11.2.3 Tropospheric propagation studies

At the IARU Region 1 Conference in Warsaw (1975), on the proposal of the RSGB Propagation Studies Committee IARU Region 1 nominated as Tropospheric Propagation Studies Coordinator Mr. R.G.Flavell, G3LTP. He resigned from this post at the conference in Tel Aviv 1996.

At the moment a successor is sought for. He will have to look into propagation effects on the microwaves ( such as 'rainscatter' )

### 11.2.4 Information exchange programme

The RSGB Propagation Studies Committee hold the official solar and ionospheric data back to the IGY, the International Geophysical Year (1967), and any information can be supplied upon application to RSGB Headquarters.

Tape/slides lecture material on auroral propagation is also available via the Hon. Secretary of IARU Region I

### 11.2.5 Co-operation with CCIR study groups and publications

Co-operation has been established with the CCIR propagation study groups 5 for tropospheric propagation, and 6 for ionospheric propagation.

Five IARU Region 1 propagation reports were submitted to CCIR study groups via F8SH, the former IARU Region 1 Sporadic-E Studies Coordinator, and, where appropriate, the attention of CCIR study groups has been and is drawn to the results of amateur investigations/observations which could be used fruitfully in their studies.

Some scientific publications which have used amateur data are

- Tropo I.E.R.E. Conference Proceedings 40 (1978) pp 265-280
  1. I.E.E. Conference Publication 169 (1978) Pt 2 pp 182-186
  2. I.E.E. Conference Publication 195 (1981) Pt 2 pp 163-167
  3. I.E.E. Conference Publication 219 (1983) Pt 2 pp 14- 18
  4. I.E.E. Conference Publication 248 (1985) pp 498-501
- Aurora I.E.E. Conference Publication 219 (1983) Pt 2 pp 259-262
  1. T.E.P. I.E.E. Conference Publication 219 (1983) Pt 2 pp 325-328

### **11.2.6 Action/support required from IARU Region 1 member societies**

IARU Region 1 considers it of the utmost importance that member societies stimulate and encourage the participation of amateurs in scientific and propagation studies. To this end wide publicity should be given to the projects already in progress, and possibilities for new projects and/or extensions of existing projects should be investigated.

In all this work close co-operation with the existing Coordinators and/or coordinating institutes is strongly recommended. As already indicated, for publications member societies can obtain information at the addresses given above.

This type of work can open a whole new field of extremely interesting activities for amateurs!  
To mention a few examples:

- Now that in some European Region 1 countries the 50 MHz band has been opened for amateur use, every effort should be made to increase the number of beacons and observation stations on this band, where many propagation modes can be studied, including modes such as back-scatter meteor trails, and, at suitable solar times, high M.U.F. propagation. As this band is not yet universally available for the Amateur Service, listening stations can play an important role here!
- VHF Managers/Contest Committees etc. should be aware of the possibility of using contest logs for the derivation of data useful for scientific studies. These logs often contain a wealth of data covering a wide geographical area, providing detailed information, particularly on tropospheric propagation, that could not be obtained in any other way. This is an excellent illustration of the main strength of the Amateur Service: the mass of observation stations!

Reporting forms (log sheets), used in the various projects and showing the data that preferably should be gathered by the participants, as well as the necessary information and instructions are obtainable from the addresses given above.

Some reporting forms already in use are appended to this section, together with some examples of information sheets accompanying these reporting forms.

### **11.2.7 Cooperation with the DUBUS magazine**

In order to facilitate the flow of information from amateurs to the coordinators a cooperation with DUBUS has been arranged in 1995 whereby the relevant DUBUS editors will share the information received with the IARU Region 1 coordinators.

### **11.2.8 Propagation database**

At the IARU Region 1 Conference 1999 in Lillehammer the offer of Michael Kastelic, OE1MCU, was accepted to create a easily accessible database for the collection and distribution of amateur reports. Appendix Sample reporting forms and information sheets ( nov 96)

## 12 VHF/UHF/ $\mu$ WAVES RECORDS

The desirability of having a list of national and international records on VHF, UHF, and MICROWAVES, which would give a good impression of the progress made by amateurs in the course of the years, has been recognized for a long time. At the meeting of the VHF Working Group in Amsterdam (1976) SM5AGM, Folke Rasvall, then VHF Manager of SSA, offered to compile an IARU Region I record table for the different modes of wave propagation. This offer was accepted with thanks, and it was agreed that:

*VHF Managers shall send OZ1FF (oz1ff@mail.dk) a list of their national DX records, covering the various modes of propagation, i.e. tropospheric, aurora, meteor scatter, sporadic-E and EME, for each of the VHF, UHF and Microwaves bands; b) the information, after having been collated by SM5AGM, shall be sent to the Hon. Secretary of IARU Region I for publication in the Region I News, e.g. once per annum; c) the VHF Manager shall send the information on any new record established in his country immediately to SM5AGM.*

The following recommendation was adopted at the IARU Region I Conference in Opatija (1966):

*In principle all QSO's via a translator system shall be in a special class and shall not be eligible for inclusion in normal Countries Worked lists or for DX-record awards. A special list for translator QSO's shall be established.*

*Each year the IARU Region I record table as well as the national record table should be published in the national amateur radio magazine, accompanied by a request to the readers for submitting necessary changes. Claimed records should be carefully checked. For instance, for tropo records check the weather map for the day in question, for sporadic-E records check the time of the year and the time of day and, if possible, compare the claim with reports on other QSO's made during the opening. It has occurred that long meteor- scatter bursts were taken for a short sporadic-E opening! Be also aware of the possibility that 28, 21 or 14 MHz QSO's may mistakenly be reported as 145 MHz QSO's by stations using transverter systems. Check whether QSL cards have been exchanged. Please note that records are only established for different propagation modes, and that the Region I list does not deal with different transmission modes (CW, SSB etc.) or with "firsts". From the above it is clear that a sound record table can only be established in close co-operation with all national VHF and Microwave Managers or Committees.*

At the IARU Region I Sub Working Group in Vienna 2013, OZ1FF, was elected as the successor of SM7NZZB .

DX Records Coordinator  
OZ1FF  
Kjeld Bülow Thomsen  
[kjeld@oz1ff.dk](mailto:kjeld@oz1ff.dk)

For the latest list of records please visit: <http://dxrecords.vushf.dk>



# PART 4

## HISTORICAL DATA

## 1 LIST OF CHANGES

### Version 8.50 (Interim meeting Vienna 2019)

- Update VHF managers list
- Defending our bands: 50 MHz and from 1GHz to 10 GHz
- European table of frequency allocation
- Adjusting the 435MHz, 1.2GHz 2.3GHz, 3.4GHz band plan
- Additional band plans for 8 and 5m band in Ireland
- Financing the contest robot
- Satellites transmitting in our bands without permission
- Principles for digital transmissions
- Digital voice coordination

### Version 8.12

- Alternative lay-out and partition from handbook 8.02

### Version 8.02

- **New contest rules added (2018)**

### Version 8.01

- Typo's

### Version 8.00

- **Complete review of the handbook**
- **Decisions from Landshut 2017 added**

### Version 7.51

- Editing bandplan 144 and 434 MHz
- Footnote 70 MHz

### Version 7.50

- Update VHF managers list
- Delete some footnotes in the 144 MHz band plan
- Adjusting 5 GHz band plan
- 5.2.2 is not for ATV
- 5.3.11: monitoring stations
- 5.3.10 major edit
- 5.3.6: adding examples
- 5.3.8: exchanges outside R1
- 5.3.2: 6H contest category
- Added guidelines for the P Sect in the EDI files
- Rules for the contest robots
- Contest organizers
- Winners will be published on the IARU-R1 website
- Delete all WSPR frequencies

### Version 7.00 (decisions from Varna 2014 added)

- Information about repeaters (1.6.5 and 10.1)
- DX Code of Conduct, Remote Control and TV Repeater Spectrum Compatibility added to Sec-2
- ITU and WRC Frequency Allocations Process (3.2)
- DX code of conduct (2.8)
- Major update from the contest section(5.2 and 5.3)
- Radar (added 7.12)
- WSPR: footnotes added where needed
- Satellite downlinks on 144 MHz
- Updated band planning issues (recommendations from Varna 2014 and layout of footnotes)
- New point 11.3 about the synchronized 50 MHz beacon project
- IPv6 allocation for amateur use (8.3.3)
- DATV footnotes on 435 MHz and technical recommendations 8.3.4.
- Complete review of ATV contest rules

### Version 6.14

- Update VHF manager list
- Minor errors fixed

### Version 6.11 (decisions from Vienna 2013 added)

## IARU-R1

- Update VHF manager list
- Minor errors fixed
- VALID CONTACTS Updated and supplemented (7.4.9)
- TECHNICAL STANDARDS FOR FM REPEATERS IN THE 145 MHz and 435 MHz BANDS updated (8.8.4)
- Entries changed (contest: 5.3.10)
- WSPR Beacons frequency changed to 144.4920
- 70.3000 FAX removed
- 2m, 70cm and 23cm changes in usage
- 2m Band Updated
- 8.8.11. recommendations for DATV added
- 11.1.7 Beacons spectrum added

## Version 6.01

- Update VHF manager list
- Minor errors fixed

## Version 6.00 (decisions from Sun City added)

- Update VHF manager list
- Minor errors fixed
- IARU Region 1 band planning: Principles – Repeater coordination added ( 2.2 )
- CTCSS frequency added ( 7.2.1 )
- FREQUENCY SPACING updated ( 5.1.4 )
- BEACON MESSAGE updated ( 10.1 )
- extra guidance for beacons added ( 10.2 )
- 67Hz added to the Table FM.2.1.
- Update Text CTCSS ( 7.2.1 )
- All bandplans up to 78Hz modified to 4 columns (frequency / maximum bandwidth / mode / usage)
- 50-52 MHz Bandplan Updated
- 70-70,5 MHz Bandplan Updated
- 144 - 146 MHz Bandplan - Repeater segment extended
- 1250 MHz Bandplan updated
- 2320 MHz Bandplan updated
- 3400 MHz Bandplan updated
- 134 - 141 GHz Bandplan Updated
- ATV contest updated
- Contest judging of entries updated ( 5.6.13 )
- Additional contest Segment 144,500 – 144,700 MHz added ( □ )
- Multiplier updated ( 5.6.11 )
- Complete new Amateur Satellite chapter ( 2 ) - (thanks to Graham Shirville, G3VZV)

## 2 IARU INFORMATION

### 2.1 IARU Region 1 VHF/UHF/μWaves Committee

#### 2.1.1 Constitution and terms of reference of the IARU-R1 VHF/UHF/μWaves Committee

At the IARU Region 1 Conference in Opatija (1966) the VHF Committee (Committee B) submitted recommendations to the final Plenary Session concerning the constitution and terms of reference for an IARU Region 1 VHF Committee and for an IARU Region 1 VHF Working Group which would continue the work in the intervals between successive Conferences. The Plenary Session decided to refer these recommendations (H and I) to the IARU Region 1 Executive Committee for further consideration.

At the meeting of the Executive Committee of IARU Region 1, held on 28 October 1967, the above recommendations were approved with minor alterations.

At the IARU Region 1 Conference in Noordwijkerhout (1987) a completely re-written IARU Region 1 Constitution was adopted. As a consequence the VHF Committee and the VHF Working Group were transformed into a so-called Specialised (Permanent) Body, the IARU Region 1 VHF/UHF/Microwaves Committee, with the same terms of reference as the previously existing VHF Committee c.q. Working Group.

In these basic documents the whole structure as well as the working procedures of IARU Region 1 and the IARU can be found. Consequently, this is **recommended reading!**

#### 2.1.2 Constitution and Bye-Laws of the IARU Region 1

Please visit: [www.iaru-r1.org](http://www.iaru-r1.org)

#### 2.1.3 Constitution and Bye-Laws of the IARU

Please visit: [www.iaru.org](http://www.iaru.org)

## **2.2 IARU Region 1 Conferences**

1950	Paris
1953	Lausanne
1956	Stresa
1958	Bad Godesberg
1960	Folkestone
1963	Malmo
1966	Opatija
1969	Brussels
1972	Scheveningen
1975	Warsaw
1978	Miskolc Tapolca
1981	Brighton
1984	Cefalu
1987	Noordwijkerhout
1990	Torremolinos
1993	De Haan
1996	Tel Aviv (Israel)
1999	Lillehammer (Norway)
2002	San Marino
2005	Davos (Switzerland)
2008	Cavtat (Croatia)
2011	Sun City (South Africa)
2014	Varna (Bulgaria)
2017	Landshut (Germany)
2020	

## **2.3 IARU Region 1 VHF/UHF/Microwaves Committee Chairs**

- Jacques Verleijen ON4AVJ (2014 - )
- Michael Kastelic, OE1MCU (2005 - 2014)
- Arie Dogterom, PA0EZ (1993 - 2005)
- Kees van Dijk PA0QC (sk) (1967 -1993)



## 2.4 Notes on tasks IARU-R1 and its VHF/UHF/ $\mu$ Waves committee

In view of the fact that the 435 MHz band is shared with the Radiolocation Service, and that difficulties have arisen regarding the frequencies allocated to the Syledis radiolocation system by some licensing authorities, the following recommendation was adopted at the IARU Region I Conference in Cefalu (1984): *On short notice societies in countries bordering the North Sea will again approach their P & T authorities with an urgent request to reconsider, both nationally and in the appropriate international co-operative bodies, the frequency allocation for the Syledis system in view of its incompatibility with the long-established Amateur Service in the 435 MHz band.*

Regarding the allocation of bands to the Amateur Services the following recommendation was adopted at the IARU Region I Conference in Cefalu (1984):

*As a few authorities in the European part of Region I have allowed some amateur activity in the 50 MHz part of the spectrum, societies are urged to again approach their P & T authorities with the aim of obtaining an allocation or assignment preferably between 50 and 55 MHz. In view of the TV activity still present in this part of the spectrum, in the first instance permission may be sought for operation outside TV broadcast hours, e.g. for experimental purposes for a selected number of stations.*

A further recommendation regarding the 50 MHz band was adopted at the meeting of the IARU Region 1 VHF/UHF/Microwaves Committee in Vienna, March 1992, and accepted as interim IARU Region 1 policy by the IARU Region 1 Executive Committee at their meeting in Budapest, April 1992. This recommendation was ratified at the IARU Region 1 Conference in De Haan (1993) and reads:

*All IARU Region 1 member societies in countries where the Amateur Service is currently not permitted to use the 50 MHz band shall endeavour to obtain such a permission in the 50 - 54 MHz band. This permission should preferably be permanent and under the same conditions as valid for the normal licences. In order to obtain a common IARU Region 1 band, the allocation band obtained should at least contain the frequency segment 50 - 50.5 MHz.*

At the meeting of the IARU Region 1 VHF/UHF/Microwaves Committee in Düsseldorf (1989) the following recommendation regarding the shared microwave bands was adopted and a few weeks later approved as interim IARU Region 1 policy by the IARU Region 1 Executive Committee at their meeting in Torremolinos, April 1989. The IARU Region 1 Conference at Torremolinos, April 1990, ratified this recommendation:

*IARU and IARU Region 1 should maintain their basic policy of trying to retain all wideband secondary allocations in the Microwave bands.*

*Note. This IARU policy is clearly set out in paper C3.35, submitted to the IARU Region 1 Conference at De Haan (1993) by the International Secretariat of IARU. At this Conference the paper (see 1.3.1.) was adopted by IARU Region 1.*

However, IARU and IARU Region 1 should also endeavour to convince Administrations that in all countries the same small region-wide common segments - in the order of 2 MHz wide - should be allocated to the Amateur Service, as commonality is a practical necessity for international amateur activities.

N.B. Already at the IARU Region 1 Conference in Noordwijkerhout (April 1987) IARU Region 1 nominated a VHF/UHF/Microwave Frequency Allocation Coordinator (see section Id). His terms of reference include carrying out the work mentioned above in behalf of IARU Region 1.

At the WARC in Torremolinos (1990) the status of the Mobile Service in the frequency segment 2300 - 2450 MHz was upgraded to Primary (see Frequency Allocation Tables). The Mobile Service and the Amateur Services must be considered to be practically incompatible, as far as the use of frequencies is concerned. Hence IARU Region 1 is making vigorous efforts - via approaches by member societies to Administrations, as well as indirect approaches to, for instance, the CEPT - to get a reasonable and common part of this frequency segment de facto or de jure exclusively allocated to the Amateur Service.

## IARU-R1

Within CEPT a large programme has been initiated from 1993 onwards to create a harmonised European frequency table. Detailed Spectrum Investigations (DSI) have been arranged and IARU Region 1 and its member societies have actively contributed to those studies. In the microwave bands this has led to retention of the existing allocations in the ITU table and in addition to a recommendation that administrations should allocate spectrum in the 3400-3500 MHz band to their amateurs. Moreover the concept of virtually exclusive narrow segments in the microwave bands has been recognised by the CEPT.

Currently amateurs in 4X, 5B, 9A, OH, OK, OZ and PA have got access to 3400-3410 MHz in addition to the (ITU footnote) allocations in Bulgaria, Norway, Poland, Germany, Slovenia and Great Britain.

The CEPT discussions about the spectrum 29.7 - 960 MHz have not yet finished in 1996 and in particular the 430-440 MHz amateur allocation, which in several Region 1 countries already is smaller or of a lower status, is under attack. At the IARU Region 1 VHF/UHF/Microwaves committee meeting in Vienna 1995 the thread to the 435 MHz band was taken seriously and all member societies in the CEPT countries were urged to lobby for retention of the "full allocation".

At the IARU Administrative Council (AC) meeting in Bandung, October 1991, the misuse of amateur bands was discussed, i.e. the use of these bands for purposes which have nothing to do with the Amateur Services by, for instance, research institutes, groups of people interested in forwarding technical information in aid of developing countries etc. - sometimes with the permission of the pertaining Administration!

Resolution 91-1 was drafted, which set out procedures aimed at giving the regional IARU organisations more possibilities for taking action in defence of the interests of the Amateur Services.

At the meeting of the IARU Region 1 VHF/UHF/Microwaves Committee in Vienna (March 1992) the following recommendation was adopted, which in April 1992 was approved by the IARU Region 1 Executive Committee at their meeting in Budapest, and later ratified by the IARU Region 1 Conference in De Haan (1993):

***Resolution 91-1 of the IARU Administrative Council is recommended for immediate adoption as interim IARU Region 1 policy until ratification by the next Region 1 Conference.***

### **2.4.1 Resolution 91-1 (concerning the improper use of the amateur bands)**

The IARU Administrative Council, Bandung, October 1991,

#### ***considering***

- the increasing number of reports received from the amateur community regarding improper use of the amateur bands,
- that in accordance with the IARU Constitution, it is the obligation of the IARU and its member-societies to defend the interests of the Amateur Services,
- that the ITU, having no enforcement authority, is unable to address such matters directly,

#### ***resolves***

- that member societies shall aggressively pursue the processing of their own administrations of documented complaints of improper use of the amateur bands,
- that documented cases of improper use of the amateur bands that cannot be solved by the member society with its administration shall be forwarded by the member-society to its regional IARU organisation, and
- that any cases of improper use of amateur bands processed through an IARU regional organisation shall be handled according to the following procedure:
  1. The cases shall be referred to the regional IARU MS coordinator in the region where the transmitting station is located.

## IARU-R1

2. As soon as possible after receiving a case, the regional IARU MS coordinator will verify the report and ensure that all pertinent information is included.
3. Upon verification, the IARU MS coordinator will ask the regional secretary to report the incident to the appropriate member-society in the region.
4. The member-society will promptly submit the report to its administration.
5. The member-society must advise the regional secretary within 30 days after receiving the report:
  - the date the report was presented to its administration;
  - to whom it was presented;
  - any formal or informal response of the administration.

### *and further resolves*

- that the IARU MS regional coordinators are encouraged to keep a log by country in their region of cases of improper use of the amateur bands and to issue a summary report to the regional secretary once a year;
- that regional conferences are encouraged to include in their conference agendas a review of cases of improper use of the amateur bands,
- that member-societies are encouraged to seek, in their countries, restrictions on the sale of amateur transmitting equipment to persons who do not hold amateur licenses, and
- that if a member-society is unable or unwilling to present a report of improper use of the amateur bands to its own administration, the member-society may request the regional organisation to present the report directly to its administration.

## **2.5 Deleted functions**

### **2.5.1 Frequency allocations coordinator**

It is been decided in Landshut that this function is redundant and it is deleted

At the IARU Region 1 Conference at Noordwijkerhout (April 1987) the final Plenary Session adopted a proposal from Committee B (now, under the new IARU Region 1 Constitution, the VHF/UHF/Microwaves Committee) to nominate a VHF/UHF/Microwaves Frequency Allocation Coordinator.

The task of the Coordinator can be summarized as follows:

Collect information from Region 1 member societies about the specific VHF/UHF/Microwaves frequency allocations to the Amateur (Satellite) Service in their countries

To use the information obtained for the creation of a survey of deviations from the allocations to the Amateur (Satellite) Service as found in the ITU frequency table, and to publish this information regularly in the VHF Newsletter and/or the Region 1 News.

To make proposals for a coordinated approach of the licensing authorities in the various countries of Region 1 by member societies with the aim of obtaining common frequency allocations, especially in the shared Microwaves bands.

N.B. In their recommendation to the Plenary Session Committee B considered this point to be most urgent in view of the fact that in various countries the authorities were already allocating segments of shared bands to the various Services without any form of co-ordination as far as the Amateur (Satellite) Service was concerned.

To provide, in as far as possible, the Committees and Working Groups of the CEPT and the OIRT with background material on the IARU and IARU Region 1 standpoints with regard to UHF/Microwaves frequency allocations to the Amateur (Satellite) Service. In matters of policy the VHF/UHF/Microwaves Frequency Allocation Coordinator will work in close consultation with the Chairman of the IARU Region 1 VHF/UHF/Microwaves Committee and the Executive Committee of IARU Region 1.

The VHF/UHF/Microwaves Frequency Allocation Coordinator will submit reports on actions taken, results obtained and future plans to the IARU Region 1 VHF/UHF/Microwaves Committee for consideration at their meetings during IARU Region 1 Conferences or in between Conferences. At the final Plenary

## IARU-R1

Session of the IARU Region 1 Conference at Noordwijkerhout (April 1987) Arie Dogterom, PA0EZ, was nominated as VHF/UHF/Microwaves Frequency Allocation Coordinator. At the meeting of the VHF/UHF/Microwaves Committee in Vienna (February 1995) John Morris, GM4ANB, was nominated as his successor. At the 1999 Conference in Lillehammer GM4ANB stepped down. PA0EZ temporarily took over. In April 2000 Heinz-Günter Böttcher, DK2NH, accepted this post.

All Region 1 member societies are urgently requested to send all relevant information such as (updates on) the national frequency allocations to the Amateur (Satellite) Service in the bands above 50 MHz approaches to the national authorities and results of discussions with the national authorities on the subject of frequency allocations above 50 MHz to the IARU Region 1 VHF/UHF/Microwaves Frequency Allocation Coordinator. His address is given on page 1f of this handbook.

Note. The recommendation of Committee B adopted by the final Plenary Session of the IARU Region 1 Conference in Noordwijkerhout (April 1987) contained the following statement:

*It is intended that copies of the results of the survey of Region 1 VHF/UHF/Microwaves frequency allocations be supplied to Regions 2 and 3 of IARU with a request for similar information, so that world-wide co-ordination can be obtained, especially with regard to satellite and EME communication.*

The Plenary Session agreed with this suggestion, stipulating that this should be done via the IARU Region 1 Secretariat.

At the IARU Region 1 Conference in Torremolinos (April 1990) Resolution 89-2, proposed by the Administrative Council and concerning the desirability of common frequency allocations on VHF/UHF/Microwaves in view of international working using modes such as moonbounce, meteor scatter etc., was adopted with a slight change in the wording. As ratified by Region 1 the recommendation reads as follows:

*Member societies should work to establish and/or maintain common frequency allocations for the Amateur Service and the Amateur Satellite Service to enable international working and facilitate bandplanning. Resolution 89-2 was drafted by the Administrative Council at its meeting in Orlando, September 1989, and, obviously, fits in seamlessly with the work already started by IARU Region at the Noordwijkerhout Conference (April 1987).*

### 2.5.2— Database keeper

The work of the propagation coordinators very much being dependant of the availability of data from amateur observations, the VHF/UHF/MW Committee at its meeting in Lillehammer 1999 decided that a common database, easily accessible for amateurs and organized in such a form that data analysis would be made relatively easy, should be set up.

The person responsible for setting up and maintaining this database will work in close cooperation with the propagation coordinators. The access to the database and the required information will be published in the Region 1 Newsletter, the Region 1 VHF Newsletter and the Internet

## 3 BEACONS

### 3.1 IARU R-1 VHF and $\mu$ Wave beacon list (deleted in Landshut 17)

This list of VHF/UHF Beacons is compiled for IARU Region 1 by G0RDI, and it builds upon the valuable work contributed by G3UUT. Many thanks to the VHF/UHF/ Microwave managers of radio societies across Region 1, beacon keepers, beacon coordinators and VHF/UHF DXers too numerous to mention.

The main Region 2 & 3 6m beacons are included in the list in italics for completeness. Thanks to G3USF, the IARU HF beacon coordinator for these. All inputs are welcome and should be sent to the address below.

*You are free to use information from this beacon list but please acknowledge IARU Region 1 and G0RDI.*

Jain Philipps G0RDI  
IARU Region 1 VHF Beacon Coordinator  
24 Acres End  
Amersham  
Buckinghamshire HP7 9DZ England  
Email: [g0rdi@77hz.com](mailto:g0rdi@77hz.com)  
Phone: +44 1494 432144

## 4 BANDPLANNING

### 4.1 Historical data

*Attention is drawn to the "Principles of Bandplanning"(see PART 2 section 1)*

At the IARU Region 1 Conference in Cefalu (1984) a 50 MHz bandplan was adopted for use in countries within the European part of Region 1 where amateurs had obtained a frequency allocation or assignment in the 50 MHz band. As an appreciable number of countries within the European part of Region 1 had obtained or expected to obtain such an allocation by the end of 1989, at the IARU Region 1 Conference in Torremolinos (1990) the first version of an official IARU Region 1 bandplan for use in that part of Region 1 where the 50 MHz allocation does not exceed 52.000 MHz was adopted.

At the IARU Region 1 Conference in Tel Aviv (1996) the bandplan was slightly amended in order to reflect practical experiences. The IARU Region-1 conference in Sun City (2011) further revised this.

At the IARU Region 1 Conference in San Marino (2002) it appeared that a significant number of DXCC countries ( e.g. EI, G, GD, GI, GJ, GM, GU, GW, S5, ZB, ZS, 5B4, ZC4 ) had got access to the 70 MHz band and it was decided to add the bandplan for that band.

Regarding amateur-satellite bandplans, the following was decided at the IARU Region 1 Conference in Warsaw (1975):

*That IARU Region 1 adopts the bandplans recommended by the sponsors of each satellite system, e.g. by AMSAT for OSCAR-7, but also informs sponsors that such bandplans must be kept simple and that in the opinion of IARU Region 1 in each case provisions should be made to segregate Telegraphy from telephony.*

The currently valid satellite bands, together with some data on amateur satellites, can be found in the amateur satellite chapter.

The appearance of manned space stations with an amateur station on board has led to the allocation of FM channel frequencies. In Vienna 1995 the former 145.200/145.800 MHz frequency pair was allocated. The following general recommendations regarding the promotion of bandplans have been adopted/re-affirmed at various IARU Region 1 Conferences:

- VHF Managers should give maximum publicity to the adopted bandplans. In view of the many newcomers, regular repetition of the publication of the bandplans is advisable.
- Member Societies, and particularly their VHF Managers or VHF Committees, should strongly promote adherence to the adopted bandplans by all VHF/UHF/Microwaves amateurs in their country.

It will be noted in the following bandplans that the accommodation of the narrow-band modes in several bands is quite similar and is modelled after the plans for the 145 MHz band which existed before the 1996 Tel Aviv conference.

The narrow-band modes parts of the higher bands are respectively:

- 432 - 434 MHz
- 1296 - 1298 MHz
- 2320 - 2322 MHz alternative 2304 - 2306 or 2308- 2310 MHz
- 3400 - 3402 MHz
- 5668 - 5670 MHz
- 5760 - 5762 MHz
- 10368 - 10370 MHz alternative 10450 - 10452 MHz
- 24048 - 24050 MHz
- 24192 - 24194 MHz till 31-12-2003 ( San Marino 2002 )

## IARU-R1

- 47.000 - 47.002 GHz
- 75.500 - 76.000 GHz (DAVOS 2005)
- 77.500 - 77.501 GHz
- 122.250 - 122.251 GHz
- 134.000 - 134.001 GHz
- 248.000 - 248.001 GHz

Note: As it cannot be expected that FM repeater systems will become operational at the microwave bands above 77 GHz the NB segment in those bands is currently limited to 1 MHz .

At the Conference in San Marino it was decided to change the basic set-up of the bandplan.

Till then the bandplans show two columns (plus a column for the frequency segments):

IARU Region 1 bandplan	Usage
------------------------	-------

The left column designation is self-explanatory. The right column contains meeting/calling frequencies, agreed upon for the convenience of the VHF/UHF/Microwave amateurs practising specific modes of communication. These frequencies are not part of the adopted IARU Region 1 bandplan and, though in the normal amateur spirit other operators should take notice of these agreements, no right on reserved frequencies can be derived from a mention in the right-hand column.

The San Marino conference started to change this, beginning with the 50 MHz and 145 MHz bands. The other bands to follow at a later moment. In this new planning there are three columns:

maximum bandwidth	Mode	Usage
-------------------	------	-------

**The maximum bandwidth** determines the maximum spectral width ( -6 dB points) of all emissions allowed in a segment.

**The mode** indicates the modulation methods ( e.g. telegraphy, telephony, MGM, etc) allowed in a segment. M(achine) G(enerated) M(ode) indicates those transmission modes relying fully on computer processing such as RTTY, AMTOR, PSK31, FSK441 and the like.

**The usage** column indicates the main usage (sometimes country dependant) of a segment. In case only one application is allowed, the word 'exclusive' is added.

The allocation of frequency segments to the various modes of operation in the IARU Region 1 bandplans is subject to the following condition:

The allocation of sub-bands in the IARU Region 1 bandplans allows the indicated category of users to employ any frequency within that sub-band, provided that no appreciable energy falls outside that sub-band. Users must therefore take into account the bandwidth of their sidebands when selecting an operating frequency. (de Haan, 1993)

## 4.2 Deleted during the Landshut conference (2017)

### 4.2.1 50 MHz

We removed:

This band plan, first adopted at the IARU Region 1 Conference in Torremolinos (1990) and revised at the 1996 Tel Aviv conference, the 2002 San Marino Conference, and the 2011 Sun City Conference is recommended for use in those countries in the European part of Region 1 which allow amateurs to operate in this part of the radio spectrum. In many countries in the African part of Region 1 (see footnotes accompanying the ITU frequency allocation table) the 50 - 54 MHz band is allocated to the Amateur Service on a primary basis. These Countries may refer to the SARL Bandplan.

### 4.2.2 144 MHz

Following footnotes were deleted, because they went obsolete:

- g. Attention is drawn to section 1.1. point iii of these Bandplan notes!

#### IARU-R1

- h. Unmanned packet radio stations and digital access points are allowed in the segment 144.800 -144.9625 MHz, provided they are fully compatible with 12.5kHz channel spacing. Any other unmanned packet radio outside of this frequency range must cease operation.
- i. Except in the part of the band allocated to the Amateur Satellite Service and the linear transponders it is not allowed to use input or output frequencies in the 145 MHz band for repeaters with in or output in other amateur bands (Miskolc Tapolca 1978, San Marino 2002).

#### **4.2.3 432 MHz**

The words, 'centre frequency of' and 'horizontal polarization' be removed to allow broadband digital experiments of footnote "m" are deleted



## 5 CONTESTING

Deleted during the Landshut Conference 2017

### 5.1 History

To stimulate activity on all VHF/UHF/Microwave bands, sub-regional contests, organised and judged by national societies, have been held since 1956. In many countries these contests have developed into national annual Trophy competitions.

The rules for the national contests are up to the national society which organises the contests. They may use the IARU Region 1 contest rules or design their own rules, deviating for instance in the manner of scoring etc.

However, experience has shown that a certain amount of international coordination is required, and hence the following rulings were adopted at various IARU Region 1 Conferences.

### 5.2 Organisation

IARU Region 1 has organised official international contests on the VHF/UHF/Microwaves bands since 1956, when an all-band contest during the first weekend of September was established.

In 1962 a separate UHF/Microwaves contest was added, which was initially held during the last weekend of May (decision Turin, 1961). From 1970 onwards this date was set at the first weekend of October (Brussels, 1969). The millimetre group was introduced during the meeting of the VHF Working Group in Vienna, March 1986, with the aim of promoting the use of these Amateur Service bands. In October 1987 this extended rule was applied for the first time.

As of 1970 an SWL contest was established, to be run concurrently with the official Region 1 VHF and UHF/Microwaves contests. The conference in DAVOS (2005) decided to discontinue the Region 1 VHF/UHF/Microwaves SWL contest.

During the IARU Region 1 Conference in Scheveningen (1972) it was decided that as of 1973 the September contest would only be held on 145 MHz.

At the IARU Region 1 Conference in Noordwijkerhout (1987) an IARU Region 1 ATV contest was added, to be held during the second weekend of September.

Finally, at the IARU Region 1 Conference in De Haan (1993) an official 50 MHz contest was established, to be held as from 1994 during the first weekend of June. In San Marino 2002 the date was changed into the third weekend of June.

Hence, currently four official IARU Region 1 contests are organised annually:

- The 50 MHz and 70 MHz (Varna 2014) contest during the third weekend of June.
- The VHF contest during the first weekend of September - only on 145 MHz;
- The UHF/Microwaves contest during the first weekend of October on 435 MHz and higher bands;
- The ATV contest during the second weekend of June;

Member societies of IARU Region 1 organise and judge the results of the above contests. The procedures for the organisation of the 50MHz, 145MHz and UHF/Microwaves contests are set out in chapter 3. The list of the organizing societies can be found in Annex 1

The IARU Region 1 ATV contest is organized and judged by a member society in a country where ATV transmissions are authorized.

The rules for the official Region 1 contests are set out in PART 1 chapter 2 (50MHz, 145MHz, UHF, Microwaves), and chapter 3 (ATV).

Attention is drawn to the fact that since 1974 during the first weekend of November the Italian member society ARI organises the Marconi-Memorial Telegraphy contest as an international contest for the whole

## IARU-R1

of Region 1. This contest, run according to the rules of the official Region 1 contests, is judged by the ARI VHF Committee, and the results are distributed to all participating countries via the VHF Managers of the member societies. This ARI contest replaces the former IARU Region 1 Telegraphy contest.

### 5.3 Procedure

Until 2016 all contests were organised in the following procedure.

#### 5.3.1 Information

In January of each year the Chairman of the VHF/UHF/Microwaves Committee shall send a letter to the societies organising the IARU Region 1 VHF, UHF/Microwaves, 50/70 MHz and ATV contests in that year, containing an up-to-date copy of the rules for these contests.

#### 5.3.2 Organisation

The IARU-R1 contest robot will be used for contest evaluation for all CW/phone contests. The contest robot is not used for ATV contests. (Vienna 2016)

The logs should be submitted either to:

- National robot or VHF Manager or to the properly nominated Contest Committee
- Uploaded directly to IARU R1 contest robot in case there is no national possibility (method a. above).
- The final evaluation is the responsibility of the organizing society. (Varna 2014)

#### 5.3.3 Timing

- The VHF Manager or the properly nominated Contest Committee should upload the logs to the IARU R1 robot no later than second Sunday after the contest.
- Preliminary cross checked results shall be published not later than third Sunday after the contest.
- Not later than the fifth Sunday after the contest the national VHF Manager or properly nominated Contest Committee shall validate the entrants of their own society.
- Stations operating temporarily outside their "home-country" are for the purpose of the contest participating as stations in the country where they operate.
- The organising society will publish the final results not later than fourteenth Sunday after the contest on IARU R1 robot web site.

The list of results should include at least the following data: call sign, Locator, score, number of QSOs, number of deleted QSOs, percentage of deleted points, ODX call sign, ODX Locator and ODX QRB.

Number of unique QSOs for every contest entrant should be included in the published contest results.

- These results shall also be published in electronic format at least on the IARU R1 web page.
- The entrants scoring highest in each section will be awarded the IARU REGION 1 AWARD. The organising society will receive the certificates from the chairman of the C5 committee (signed by the R1 secretary) and will send those after having filled in the relevant data and after signature to the winners in each section.  
Certificates for all participants will be provided by mail directly from the contest robot. (Varna 2014)
- The DARC will host the ceremony during the yearly HAM radio in Friedrichshafen for the first 3 stations in each category. The prizes will be sponsored by the organizing society. (Vienna 16)

5.3.4 Flow chart contest evaluation

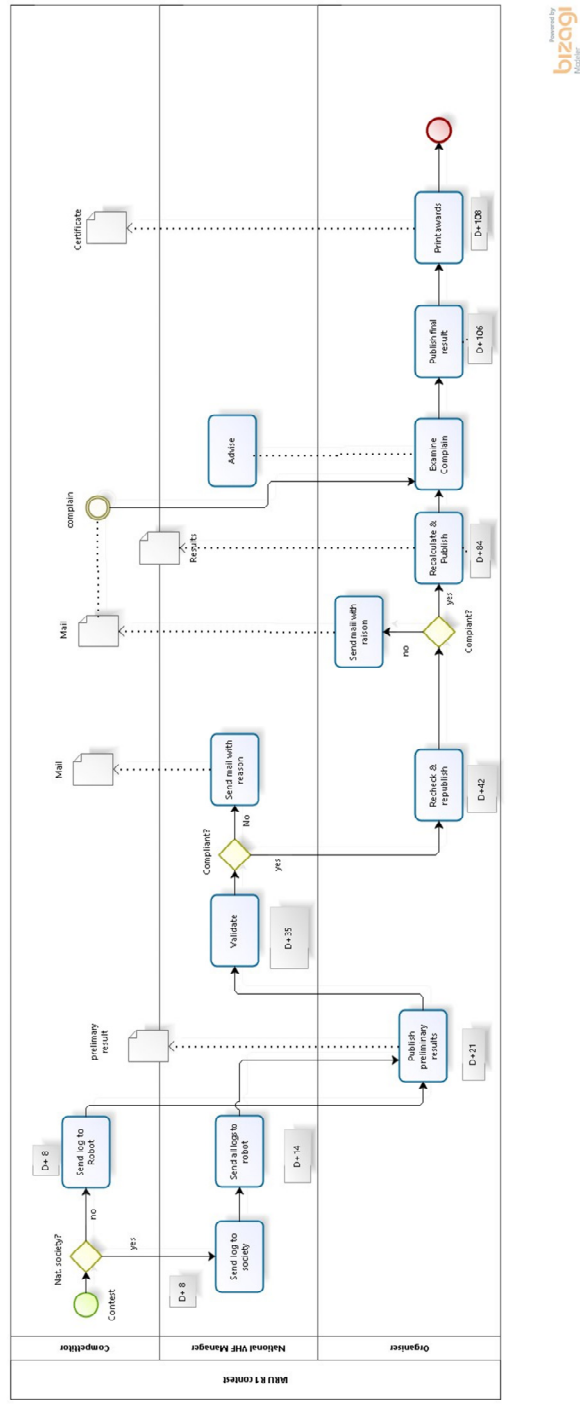

## 5.4 Rules

### 5.4.1 All-band sub-regional contests

At the IARU Conference in Folkestone (1961) it was agreed that during sub-regional contests code numbers and Locator should be exchanged according to the rules for IARU Region 1 VHF/UHF/Microwaves contests.

In view of the rather different contest conditions in the various parts of Region 1 the following minimum co-ordination, adopted at the Region 1 Conference in Malmö (1963) and later slightly amended at the Scheveningen Conference (1972) and the Brighton Conference (1981) has been agreed:

- All sub-regional contests will be held between 14.00 UTC on Saturday and 14.00 UTC on Sunday.
- All VHF/UHF/Microwaves Field Days, organised within Region 1, shall coincide as to dates and time limits with sub-regional or official IARU Region 1 contests. At the San Marino 2002 conference it was agreed to recommend that such field days should coincide with the IARU Region 1 VHF/UHF/Microwave contest in July.

At the IARU Region 1 Conference in Brussels (1969) it was agreed that the sub-regional contest during the first weekend of November shall be a Telegraphy contest, run according to the rules of the official Region 1 contests. Since 1974 ARI has organised the Marconi Memorial Telegraphy contest during this weekend and has invited all Region 1 amateurs to participate.

Furthermore, at the IARU Region 1 Conference in Cefalu (1984) it was agreed that

- Sub-regional contests on the coordinated dates shall be all-band events, 145 MHz through 240 GHz.

On this basis in many countries member societies of IARU Region 1 organise national contests during the first weekends of March, May, July, September, October and November, whereby the September and October national contests are run concurrently with the IARU Region 1 contests on these weekends.

In view of the fact that in an appreciable number of countries the 50 MHz band had become available to the Amateur Service, the meeting of the IARU Region 1 VHF/UHF/Microwaves Committee in Vienna, March 1992, adopted the following recommendation:

- From 1993 national societies are encouraged to establish 50 MHz sections in the sub-regional contests.

This recommendation was approved by the Executive Committee of Region 1 at their meeting in April 1992, and ratified by the 1993 IARU Region 1 Conference.

National VHF Managers or properly nominated Contest Committees should send the electronic contest log data entries from IARU R1 contests to a special web page to allow an exchange of logs for more accurate national evaluation. (Cavtat 2008). At present time <http://hamradio.pl/sp7nrx/index.php> is in use.

### 5.4.2 Microwave contest

At the IARU Region 1 Conference in Scheveningen (1972) it was agreed that National societies shall organise sub-regional contests on the microwave (1.3 GHz and higher) bands during the third weekend of June.

At the IARU Region 1 Conference in Noordwijkerhout (1987) it was decided that from 1988 onwards the sub-regional microwave contests will take place on the *first weekend of June*.

During the IARU Region 1 Conference in Landshut (2017) it was decided that the 3.4 GHz band will be accepted as a contest band.

#### 5.4.3 Experiment with scoring system: Locator bonuses

On the subject of scoring at the IARU Region 1 Conference in Noordwijkerhout the following recommendation was adopted:

- Societies are encouraged to try out a system of locator bonuses, such as proposed by EDR, in their national VHF/UHF/Microwaves contests.

#### 5.4.4 Introduction of locator bonus in contests

From the EDR proposal, document NN 100 amended, submitted to the IARU Region 1 Conference at Noordwijkerhout (1987):

*To encourage participants in the regional and sub-regional contests to turn their antenna towards less-populated areas, EDR proposes the introduction of a Locator-Bonus in the contest rules. For several years this principle has, with success, been in use in Scandinavia.*

If the Locator-Bonus is used, we expect to see growing activities in the "outskirts" of Europe, where it is low, dying or completely dead now. This is due to the fact that contest activity in central Europe is so high nowadays, that any good station can work "local" stations for most of the contest period. Only during the night there appears to be time to work "DX" to the remote areas.

Currently these remote stations, when participating in the contests, only work a limited number of stations during the first hours of a contest and thereafter quickly go QRT.

If the "remote" stations would get more attention by being more "attractive" (bonus points), they will, undoubtedly, also become more active and we may expect a positive development in the contest activity. After discussion in Committee B it was decided to recommend that this system be tried out in national contests.

The following bonus system was mentioned as a starting point for the experiments:

For each new locator square worked

- on the 145 MHz and 435 MHz bands: 1000 points
- on the microwave bands: 300 points

#### 5.4.5 Information exchange on contests

To ensure that participants in the various contests will know on which times or time intervals they may expect activity in other countries on the bands, at the Conference in Malmö (1963) and at later Conferences the importance of exchanging information on contests was stressed. At the IARU Region 1 Conference in Warsaw (1975) the following recommendation was adopted:

*In order to promote greater uniformity in the timing (and perhaps style) of Region 1 VHF/UHF/MICROWAVES contests, all member societies are invited to send well in advance of the contest dates, say annually, details of their contest calendar - dates and times - in English to the Hon. Secretary of Region 1 for publication in Region 1 News and for forwarding to all VHF Managers for information.*

*The Hon. Secretary of Region 1 has requested to send this information to the Region 1 Secretariat not later than the 31st December of each year.*

## 5.5 VHF/UHF/ $\mu$ Wave Challenge trophies and medals: history and winners

Till 1989 the rules for the official IARU Region 1 contests stated that the participants in the IARU Region VHF/UHF/Microwaves contests competed for four Challenge Trophies. These Trophies had come into existence and were awarded in the following manner.

IARU Region 1 contests have always been run with two categories of stations on each band. At the VHF Working Group meeting in The Hague in 1959 these two groups were defined as follows :

- section 1
  1. Home stations fixed
  2. Genuine alternative address stations
- section 2
  1. Portable stations fixed (using the mains)
  2. Portables and mobiles independent of the mains

At the same meeting in The Hague, through the good offices of VERON, the **IARU Region 1 VHF trophy** was donated by NEAL Crystals Ltd. At that time the only Region 1 contest was an all-band event held during the first weekend of September. It was decided that as of 1959 the Trophy would be awarded to the highest scorer on 145 MHz in this contest, irrespective of the category (section).

As could be expected, in most cases this was a station competing in the portable category, section 2. To remedy this situation, at the Region 1 Conference in Folkestone (1961) PZK donated the **PZK Trophy**, to be awarded to the station in the other category (section) on 145 MHz from 1961 onwards.

The awarding procedure could, of course, lead to a switching of the Trophies between sections, depending on whether a home or a portable station had scored highest. Hence, in order to simplify matters, as of 1966 the Region 1 VHF Trophy has been awarded to the winner in section 1 and the PZK Trophy to the winner in section 2 on 145 MHz.

When in 1973, at the VHF Working Group meeting in Baunatal, it was decided to organise the Region 1 September contest only on 145 MHz, nothing had to be changed in the awarding of the Trophies.

At the Region 1 Conference in Malmö (1963) I1XD, VHF Manager of ARI, offered the **Vittoria Alata Cup** to be awarded to the highest scorer in the Region 1 UHF/Microwaves contest, irrespective of the section the winner would compete in. In 1966, at the Conference in Opatija, I1XD donated a **second Vittoria Alata Cup**, and as of that year the **Vittoria Alata Cup I** has been awarded to the winner in section 1 on 435 MHz, and the **Vittoria Alata Cup II** to the winner in section 2 on 435 MHz.

At the Region 1 Conference in Scheveningen (1972) a recommendation was adopted to establish as of 1973 overall UHF/Microwaves contest winners in each station category (section) with the aid of a multiplier system for points made on the various bands. It was decided to maintain the system established for awarding the Challenge Trophies, and to award IARU Region 1 medals to the overall UHF/Microwaves contest winners.

Later it appeared to be more practical to award a **IARU REGION 1 CERTIFICATE** to those winners. Those certificates will be provided by the chairman of the VHF/UHF/Microwaves committee to the adjudicating society for signature and distribution to the winners.

At the IARU Region 1 Conference in Miskolc-Tapolca (1978) the station categories (sections) were changed to

- **section 1**: stations operated by a single operator, with no assistance during the contest, using privately owned equipment and antennas and operating from any location
- **section 2**: all other entrants

## IARU-R1

The system for awarding the Trophies to the winners in the various sections in the 144 MHz and the 435 MHz bands was maintained.

At the IARU Region 1 Conference in Torremolinos (April 1990) the Chairman of the VHF/UHF/Microwaves Committee had to announce that diligent efforts to trace the whereabouts of these Trophies has met with no success.

During the last decades the Trophies had never been sent to the winners, as in the past difficulties had been experienced with custom duties etc., but the winners only received a special certificate. The IARU Region 1 Trophy and the PZK Trophy were probably retained by early winners, though this is by no means sure. The Vittoria Alata Cups have always been in the possession of I1XD, ( who did send the winners a photograph of the cup with the call-sign engraved ) but could not be found by his family after his demise.

At the IARU Region 1 Conference in Torremolinos (April 1990) it was decided to remove the Challenge Trophies from the contest rules. In case new Trophies would be donated, it was agreed that these would be retained at the IARU Region 1 Secretariat, and that only special certificates with pictures of the donated Trophies would be sent to the various winners.

## 5.6 Rules until 2017

### 5.6.1 Definitions

#### 5.6.1.1 Station:

set of antennas, transmitters and receivers used during the contest on each frequency band (i.e. multiband setups are composed of multiple stations).

#### 5.6.1.2 Location:

geographical area with diameter of no more than 500 meters where the station resides during the contest.

#### 5.6.1.3 Call Sign:

identification of the station during the contest. Added prefix and/or suffix do not generate different call sign (i.e. S50AAA/p or DL/S50AAA are the same call sign as S50AAA).

#### 5.6.1.4 Operator:

an individual that operates the station during the contest using the station's call sign. Operator may reside inside (local operator) or outside (remote operator) the location. During the contest, an operator may operate only stations that form one entry.

#### 5.6.1.5 Multi operator:

stations from the same location, operated by more than one operator and using one callsign on all bands.

#### 5.6.1.6 Single operator:

stations from the same location, operated by a single operator and using one callsign on all bands, with no operational assistance of another person during the contest.

### 5.6.2 Eligible entrants

All licensed radio amateurs in Region 1 may participate in the contest. Multiple operator entries will be accepted, provided only one callsign per band is used during the contest. When such stations use a different call sign on each band, the logs of that Multi-operator entry shall for each band clearly bear an indication of the group. This will preferably be one of the call signs used, but a group name may be used instead. All stations belonging to such a group shall operate from the same location. A Station operated by more than one operator and using the same call sign on different frequency bands is eligible for MULTI section only. (Varna 2014)

The contestants must operate within the letter and spirit of the contest and at no greater power than permitted in the ordinary licenses of their country. Stations operating under special high power licenses do so "hors concours" and cannot be placed in the contest proper.

### 5.6.3 Contest sections

The contests shall comprise the following sections for each band from 50 MHz to 10 GHz and for the Millimetre group (the combined group of amateur bands above 10 GHz):

- **Section SINGLE:** stations operated by a single operator, with no operational assistance of another person during the contest.
- **Section MULTI:** stations operated by multiple operators
- **Section SINGLE – LOW POWER:** stations operated by a single operator, with no operational assistance of another person during the contest, transmitting with less than 100 W PEP and using single directional antenna (with only one radiating element - i.e. 9 element Yagi or 4 element loop) for transmit and receive (144 MHz only).
- **Section MULTI – LOW POWER:** stations operated by multiple operators transmitting with less than 100 W PEP and using single directional antenna (with only one radiating element - i.e. 9 element Yagi or 4 element loop) for transmit and receive (144 MHz only).
- **Section 6 HOURS SINGLE:** stations operated by a single operator, with no operational assistance of another person during the contest (144 MHz and 432 MHz only).
- **Section 6 HOURS MULTI:** stations operated by a multiple operators (144 MHz and 432 MHz only).



## IARU-R1

- **Section SINGLE without MGM:** stations operated by a single operator, with no operational assistance of another person during the contest (50 MHz and 70 MHz only).
- **Section SINGLE with MGM:** stations operated by a single operator, with no operational assistance of another person during the contest on (50 MHz and 70 MHz only).
- **Section MULTI without MGM:** stations operated by a multiple operators (50 MHz and 70 MHz only).
- **Section MULTI with MGM:** stations operated by a multiple operators (50 MHz and 70 MHz only).

### 5.6.4 6 HOURS section time rule:

the 6 hour time segment can be divided into maximum two periods. The time of the first QSO sets the start time of the first period. The pause between the two periods must be longer than 2 hours. The first time difference of 2 hours or more between two consecutive QSOs marks the pause segment. Only the QSOs that fall into the combined 6 hour time segment will be counted for points. (Varna 2014)

Participants are welcome to operate longer than 6 hours and in such case they shall send their complete log (the contest robot will automatically extract the 6 hours part from the log, while the rest of the log entries will be used for cross-checking purposes). (Vienna 2016).

### 5.6.5 Operating

- No more than one transmitter per band may be in use at any one time.
- A participating station must operate from the same location throughout the event.
- All the equipment of the station (transmitters, receivers and antennas, etc) must be located within a single circle of no greater than 500 metres diameter.

**The operator** may reside outside the station's area ("remote station"), connected to the station via a "remote control terminal". In such a case, the Locator for the contest is the Locator of the station's position. An operator may only operate one single station, regardless if it is locally or remotely operated, during the same event.

### 5.6.6 Date of contests

- The **50/70 MHz** contest will begin on the third Saturday of June.
- The **145 MHz** contest will start on the first Saturday of September.
- The **UHF/Microwave** contest will start on the first Saturday of October.

### 5.6.7 Duration of contests

The contest will commence at 1400 hours UTC on the Saturday and end at 1400 hours UTC on the Sunday.

### 5.6.8 Contacts

Each station may only be worked once per band, whether it is fixed, portable or mobile. If a station is worked again during the same contest on the same band, only one contact may count for points, but any duplicate contacts should be logged without claim for points and clearly marked as duplicates. Contacts made via active repeaters and EME contacts do not count for points. Competitors are obliged to follow the common definition for a valid QSO (described in the PART 1 section 4.1). The contest exchange (call, report, QSO number and locator) shall be sent and confirmed on the band where the contact started and only during the QSO. No attempt should be made during the QSO to obtain any part of the required exchange information via other communication methods such as the Internet chat channel, DX Cluster, talk-back on another amateur band, telephone etc.. Such a secondary method invalidates the contest QSO. Self-spotting (advertising its own frequency) on any other communication means, like DX Cluster, chat rooms, etc. shall not be used during the contest. (Varna 2014)

**Acceptable examples** when using a secondary method:

---

## IARU-R1

- "Shall we make a sked on 144.388?"
- "I have QRM, let's move to 144.218 kHz and start again"
- "Nothing received, please try again" and the QSO starts again
- "Thank you for a nice QSO" - Note: Only after the QSO has completed on the radio!

### Unacceptable examples when using a secondary method:

- "I need your serial number"
- "Please repeat all information"
- "Please confirm <report>, <serial number>, <locator> etc."

### 5.6.9 Type of emission

Contacts may be made in A1A, J3E or F3E (G3E). MGM mode is allowed during the 50/70 MHz contest. (Varna 2014)

### 5.6.10 Contest exchanges

Code numbers exchanged during each contact shall consist of the RS, RST or RSQ (MGM mode) report, followed by a serial number commencing with 001 for the first contact on each band and increasing by one for each successive contact on that band. This exchange must immediately be followed by the complete Locator of the sending station (examples: 59003 JO20DB or 579123 IN55CC).

For contact on 50 MHz, outside of Region 1, the locator can be 4 digits and "MM" will be added as 5<sup>th</sup> and 6<sup>th</sup> digit. (Vienna 2016)

Note: for the "T" part of the report, PART 3 section 2.1.2. For the "Q" part of the report, see PART 3 section 2.2

### 5.6.11 Scoring

For the amateur bands up to 10 GHz inclusive, points will be scored on the basis of one point per kilometre, i.e. the calculated distance in kilometres will be truncated to an integer value and 1 km will be added.

The centre of each locator square is used for distance calculations.

In case that only a 4-character locator has been received, the contact is invalid; except (50 MHz outside Region 1, see 2.9)

In order to make contest scores comparable, for the conversion from degrees to kilometres a factor of 111.2 should be used when calculating distances with the aid of the spherical geometry equation (Noordwijkerhout, 1987).

All QSOs including unique QSOs shall count for points even if they only appear in the log of one contest entrant (Varna 2014)

For the combined higher bands (Millimetre group) the score will be the sum of the points scored on each of the bands, using the following multiplication factors for the number of kilometres scored on each band:

- 24 GHz 1 x
- 47 GHz 2 x
- 75/80 GHz 3 x
- 122 GHz 4 x
- 134 GHz 8 x
- 245 GHz 10 x

### 5.6.12 Entries

The entries must be set out in digital/electronic form fulfilling the requirements under rule 5.3.13. Logs shall be sent according to rule 5.2.3 not later than the second Monday following the contest weekend. Late entries will be accepted as check logs. By submitting the contest or check log, an entrant agrees that he / she has:

## IARU-R1

- understood the contest rules and agrees to be bound by them,
- operated according to all the rules and regulations that pertain to his and/or station license,
- agreed the cross-checked log may be made open to the public, except for the personal data in PAdr1, PAdr2, RName, RAdr1, RAdr2, RPoCo, RCity, RCoun, RPhon and RHBBS lines of EDI file format,
- accept all decisions of the organizing society (contest organizer) as final.

(Vienna 2016)

### 5.6.13 Judging of entries

The final judging of the entries shall be the responsibility of the organising society, whose decision shall be final. Entrants deliberately contravening any of these rules, attempting fraud or flagrantly disregarding the IARU Region 1 bandplans shall be disqualified.

Each VHF Manager and/or national Contest Committee shall be responsible for monitoring during contests. Additional monitoring stations may be appointed. The national VHF Manager/Contest Committee is responsible for disqualification based upon the results of monitoring. The claimed contact shall be disqualified for any error in the information logged by the station.

Any error in the exchanged information logged by a station is liable to result in the loss of all points for that contact, subject to review and confirmation by the contest organiser.

The final judging of the entries shall be the responsibility of the organising society, whose decision shall be final. Entrants deliberately contravening any of these rules, attempting fraud or flagrantly is regarding the IARU Region 1 band plans shall be disqualified.

Each VHF Manager and/or national Contest Committee can propose to the contest organizer disqualification or penalization of an entrant. The claimed contact shall be disqualified for any error in the information logged by the station.

Any error in the exchanged information logged by a station is liable to result in the loss of all points for that contact, subject to review and confirmation by the contest organiser.

The claimed contact shall be disqualified for any error in the information logged by the station. When there is high evidence that the error is due to the wrongly logged information of the transmitting station (i.e. wrong date/time or call/UL) such a LOG shall not be used for adjudication purposes.

### 5.6.14 Use of secondary means

If an entrant will attempt to complete a QSO with a secondary method (as Internet chat channel, DX Cluster, talk-back on another amateur band, telephone, etc.), or improperly use any means for self-spotting he will receive from the C5 Contesting WG a Yellow Card.

The list of stations that receive Yellow Cards will be published at the end of the Final Classification.

An entrant or operator receiving two yellow cards over three consecutive IARU Region 1 contests (50 - 70/VHF/USHF) will be disqualified. If the entrant is in a multi-operator category, all listed operators are so affected.

C5 Contesting WG will be responsible for these actions; every National VHF Contest Manager could suggest such penalizations.

### 5.6.15 Awards

- **Section winners:**

Certificates will be issued by the organising society to the winners in the two sections on each band up to 10 GHz and for the Millimetre group.

- **Overall winners for UHF/Microwave contest:**

For each section an overall winner of the IARU Region 1 UHF/Microwaves contest will be declared. For this competition the scores of the entrants on the following bands will be combined, using an adaptive multiplier system:

1. 435 MHz
2. 1.3 GHz

## IARU-R1

3. 2.4 GHz
4. 3.4 GHz (Landshut 2017)
5. 5.7 GHz
6. 10 GHz
7. Millimetre group

The multipliers to be used for the determination of the overall scores in each section are found as follows:

- The multiplier is equal to the ratio between the highest number of points scored by any participating station on the 435 MHz band for that section and the highest number of points scored by any participating station on the band for that section for which the multiplier is being determined.
- For the millimetre group the scores as determined according to rule 2.10 are used for the determination of this group's multiplier.
- As the 3.4 GHz band is not yet available in all countries within Region 1, the 3.4 GHz results will not be taken into account when determining the overall winners of the sections in the October IARU Region 1 UHF/Microwaves contest (Noordwijkerhout 1987 )

### 5.6.16 Logs

The logs shall be in the format defined in PART 3 Section 5

Please visit also the IARU Contest robot: [iaru.oevsv.at](http://iaru.oevsv.at)

## 5.7 List of member societies charged with organising the IARU-R1 contests

Year	50 MHz	144 MHz	UHF/SHF/ $\mu$ W	ATV
1956		DARC		
1957		RSGB		
1958		VERON		
1959		ARI		
1960		SRJ		
1961		SSA		
1962		USKA		
1963		ÖVSV		
1964		UBA		
1965		EDR		
1966		REF		
1967		DARC		
1968		PZK		
1969		CRCC		
1970		SRAL		
1971		NRRL		
1972		RSGB		
1973		SSA		
1974		SRJ		
1975		ÖVSV		
1976		ARI		
1977		VERON		
1978		USKA		
1979		UBA		
1980		EDR		
1981		DARC		
1982		PZK		
1983		NRRL		
1984		RSGB		
1985		SSA		
1986		CRCC		
1987		VERON		UBA
1988		SRAL		RSGB
1989		ARI		?
1990		BFRA		VERON

## IARU-R1

1991		RSGB		RSGB
1992		DARC		UBA
1993		ÖVSV		DARC
1994	EDR	USKA		VERON
1995	SSA	UBA		REF
1996	NRRL	CRCC		UBA
1997	RSGB	FRR		RSGB
1998	FRR	VERON		VERON
1999	PZK	RSGB		DARC
2000	HRS	DARC		UBA
2001	ARI	ARI		REF
2002	CRC	SRAL		RSGB
2003	SSA	SARA	ZRS	DARC
2004	EDR	ÖVSV	REF	VERON
2005	PZK	REF	URE	REF
2006	VERON	CRC	REF	UBA
2007	PZK	MARSZ	CRC	DARC
2008	ZRS	HRS	RSGB	RSGB
2009	PZK	REF	PZK	UBA
2010	UBA	SARA	ZRS	REF
2011	VERON	DARC	DARC	UBA
2012	DARC	DARC	DARC	UBA
2013	DARC	DARC	DARC	UBA
2014	DARC	DARC	DARC	UBA
2015	DARC	DARC	DARC	VERON
2016	DARC	DARC	DARC	VERON
2017	?	?	?	VERON
2018	IARU-R1	IARU-R1	IARU-R1	RSGB

## 6 LOCATOR SYSTEM

Deleted and replaced during the Landshut conference 2017

### 6.1 History

The scoring in official IARU Region 1 contests as well as in most sub-regional contests is based upon the distance in kilometres between two stations making a complete QSO. To facilitate the measurement of this distance, at a meeting of the VHF Working Group in The Hague in October 1959 a code system was adopted for giving the location of a station. This was the QRA-Locator system, devised in Germany, originally based on a two-stage sub-division of geographical longitudes and latitudes starting from the Greenwich meridian and from 40 degrees North. At the Region 1 Conference in Malmö (1963) the system was refined by introducing a third sub-division, and in its final form the QRA-Locator consisted of a five-character code, viz. two capital letters, a two-digit number and a lower-case letter, for example CM72j.

Many Region 1 societies developed maps based on this system, either of their own country or of larger parts of Western Europe.

At a meeting of the Region 1 VHF Working Group in Brussels (1965) Dr. H.R.Lauber, HB9RG, VHF Manager of USKA, showed the first prints of the Region 1 QRA-Locator map, issued on four sheets and made through his good offices at the request of the VHF Working Group.

At the Region 1 Conference in Opatija (1966) this map was adopted as the official Region 1 QRA-Locator map, while at the Region 1 Conference in Scheveningen the system was re-baptised with the more appropriate name QTH-Locator. In the meantime it had become very popular and was used not only during contests but also for general amateur work on the VHF/UHF/SHF bands. For instance, collecting "squares" (the first two letters of the QTH-Locator indicating a square of 2 degrees longitude wide and 1 degree latitude high) became one of the most widely practised sports.

When amateurs outside Region I, especially in North America (Region II), became interested in using a form of QTH-Locator during their contacts, contests etc. and started investigating the system devised in Region I, they found this Locator system repeated itself several times around the globe. Hence they considered this ambiguous system not very suitable for exchanging QTH information, for instance during EME contacts.

Furthermore, the QTH-Locator system was not very consistent in the set-up of sub-divisions, particularly with regard to the fifth character (letter). A more consistent system, if introduced, would be of use to the many amateurs who employed computers - from PC's to programmable pocket calculators - to calculate distances and determine antenna directions from QTH-Locators.

For reasons like the ones outlined above, at a meeting of the IARU Region 1 VHF Working Group in Amsterdam (1976) SM5AGM, VHF Manager of SSA, proposed to start discussions on a better Locator system that could replace the existing one and would be usable world-wide.

As there would not be much sense in changing to a world-wide applicable Locator system in Region 1 if the other Regions would not adopt it, at the Region 1 Conference in Miskolc-Tapolca (1978) it was agreed that Region 1 would consult the other two Regions on this matter. This consultation resulted in an exchange of system proposals between the Regions, and at a certain moment more than 20 different systems and variations on systems, generated in the various Regions, were under consideration!

At the VHF Working Group meeting in Maidenhead (1980) it was felt that the time had come to make a choice, and it was agreed that the best choice would be the system devised by John Morris, G4ANB, be it with a modification concerning the starting point of the grid of the first sub-division. This system was widely published in amateur magazines of member societies in Region 1 as well as in the other Regions.

Thanks to the effort of Folke Rasvall, SM5AGM - aided, amongst others, by ZL2AMJ (Region III) and W1XX (Region II) - agreement between the Regions could be reached and all Regions have now accepted the so-called Maidenhead Locator which henceforth will simply be known as the Locator.

Region II adopted the Locator in 1982, Region III in 1983. At the IARU Region 1 Conference in Cefalu (1984) Region 1 adopted the Locator system, and the introduction date was set at January 1, 1986. As from this date all official Region 1 contests are run using the new Locator system.

## 6.2 Description of the Locator system

This description was replaced by a new one during the Conference in Landshut 2017.

The Locator system is a grid system, allowing to give the location of a station by a code consisting of six characters, viz. two capital letters, a two-digit number and, again, two capital letters. For example : JO31DG.

The system is set up as follows. The globe is divided in  $18 * 18 = 324$  fields, each 20 degrees longitude wide and 10 degrees latitude high. Each of these fields is divided in  $10 * 10 = 100$  squares, each 2 degrees longitude wide and 1 degree latitude high. Finally, each of the squares is divided in  $24 * 24 = 576$  sub-squares, each 5 minutes longitude wide and 2.5 minutes latitude wide. The coding/numbering is, as shown in Appendix 2, always from west to east and from south to north, and the origin of the system is at 180 degrees west, 90 degrees south.

As far as "squares" are concerned, the system is compatible with the old QTH-Locator system, both having squares of 2 degrees longitude, 1 degree latitude. The only difference, of course, is in the coding; for instance, square CM in the QTH-Locator system will in the Locator system be square JO22. Consequently, for the collectors of "squares" continuity is assured.

At the 1999 Conference in Lillehammer it was decided that a more precise definition of Alongitude@ and Alatitude@ was required. The conference decided that the latitude and longitude to be used as a reference for the determining of locators should be

## 6.3 Basis for determination of locators

The SRAL has proposed the WGS-84 geodetic system as a basis for converting latitude and longitude into a Maidenhead Locator.

This proposal is important, because it thereby establishes the necessary link of the World-Wide Maidenhead Locator system with an international geodetic system.

The latitude and longitude system of the Earth must be linked to a 'zero point'. This point may be called a geodetic center point. There are many such points in use; by cities, countries, continents, and for the whole world. These Azero points@ are usually not coincidental. Therefore it is important to establish which geodetic system the Maidenhead Locator System should be linked to.

When using a map or a GPS (Global Positioning Satellite) receiver to determine a Maidenhead Locator, it is possible to have the map or the GPS receiver calculate the locator on the basis of many different geodetic systems. In Europe the most commonly geodetic system used up to recent time has been the European Datum of 1950, called ED-50.

The few last year's more and more maps use their latitude and longitude linked to the newer world-wide geodetic system World Geodetic System 1984, called WGS-84.



#### IARU-R1

The difference between latitude/longitude on ED-50 versus WGS-84 is of the order of 300 meters. This has no practical consequence to radio amateurs calculating their Maidenhead Locator square other than the radio amateurs close to the square borders. Then it has consequence for contest square multipliers.

### 6.4 Extended locator system

The proposed extension follows the pattern of the Locator system by dividing each sub-square into a 10 by 10 grid of even smaller squares, each 0.5 ' from west to east and 0.25 ' from south to north. These sub-sub-squares are called "micro-squares".

Two digits are added to the Locator. The first gives the longitude co-ordinate of the "micro-square" and the second the latitude co-ordinate. For example, the region covered by Locator "IO86HA" would be divided as follows:

#### IO86HA

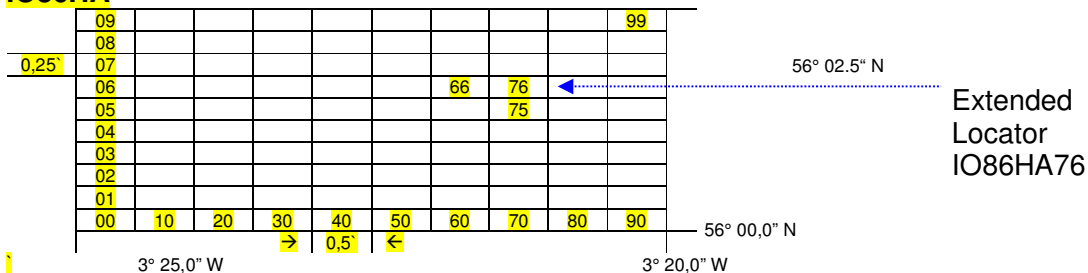

Adopted at the IARU Region 1 Conference in De Haan (September 1993) on the proposal of the RSGB. This extension is intended only for use by stations who require greater precision than obtainable with the Locator system. For normal VHF/UHF/Microwave work the existing six-character Locator is adequate. This extension should be published within Region 1 and communicated to Regions 2 and 3 with a view to eventual world-wide agreement.

## 7 DIGITAL COMMUNICATION

### 7.1 Data-transmission ( Recommendations D.1.1. and D.1.2.) - removed

#### 7.1.1 IARU Region 1 Technical Recommendation D.1.1

WARSAW 1975, CEFALU 1984

##### GENERAL RTTY STANDARD

The RTTY signalling speed to be 45.45 bit/s. The use of a higher speed than 50 bit/s is not considered appropriate at this time,

The RTTY transmission mode to be FSK on all bands with a preferred shift of 170 MHz on the bands below 30 MHz and 170 or 850 Hz above 30 MHz. The mark signal shall be the higher radiated frequency, Reception of RTTY by means of a two-tone system is encouraged for optimum communications effectiveness,

In the interests of bandwidth efficiency and communications effectiveness AFSK operation on AM transmitters is not encouraged. Where AFSK operation is used on VHF-UHF for local and autostart communications the use of FM transmitters is strongly encouraged. In the interests of bandwidth efficiency the use of a standard AFSK shift of 170 Hz is recommended. In this case the standard AFSK tones should be 1275 Hz "space" and 1445 Hz "mark". If 850 Hz shift is used the "mark" frequency should be 2125 Hz.

##### AMTOR/RTTY STANDARD

All IARU member societies shall adopt CCIR 476-1 in both modes "A" and "B" and Region 1 shall be asked to liaise with Regions 2 and 3 so that AMTOR may become a truly international standard

A speed of 45.45 bit/s is currently recommended, however speeds of 50, 75 and 100 bit/s should be encouraged

Each society - only where such requirements still exist - should press their respective licensing authorities to remove the requirement for "dual identification" when using the international standard CCITT number 2 code

The minimum specification for the signalling format should be 1 start bit, 7 data bits, 1 parity bit, 1 stop bit.

The parity should be as follows :

if generated even parity

if not generated parity bit set to space.

#### 7.1.2 IARU Region 1 Technical Recommendation D.1.2

NOORDWIJKERHOUT 1987

##### STANDARDS FOR DIGITAL COMMUNICATIONS

- Modulation methods
  1. FM/AFSK (where allowed in the bandplans)
  2. FSK : at speeds below 300 bit/s FSK is preferred
  3. PSK : at speeds above 300 bit/s PSK is preferred
- General Applications :
  1. Shifts for FSK and FM/AFSK :
  2. at 1200 bits per second -1 kHz
  3. below 1200 bits per second -850 Hz, 170 Hz (preferred)
  4. Mark is always the higher frequency.
  5. Note. For FM/AFSK the audio frequencies are :
  6. - space 1275 Hz
  7. - mark 1445 Hz or 2125 Hz, depending on shift
- Packet-Radio Applications: 1)
  1. for 300 bit/s transmissions using FSK a shift of 200 Hz should be used;
  2. for 1200 bit/s transmissions using FM/AFSK audio frequencies of 1200 and 2200 Hz should be used (as in the Bell 202 standard).
  3. On the bands below 30 MHz the signalling speed shall not be more than 300 bit/s.

#### IARU-R1

- Coding/bit- rates 6)
  1. Baudot : 45.45, 50, 100 bits per second (50 bit/s preferred)
  2. ASCII : 1 start bit, 7 data bits, 1 parity bit, 1 stop bit.
  3. Parity: if generated - even parity
  4. if not generated - parity bit set to space
  5. 110 bits per second preferred.
- Protocols
  1. Packet Radio : AX-25 as published by ARRL
  2. AMTOR : CCIR 476-1, modes A and/or B.

## **7.2 Digital telephony ( Recommendation D.2.) (removed DAVOS 2005)**

---

<sup>6</sup> Packet-Radio : It is recognised that in the future higher data rates will be achievable through the use of different modulation methods. It is recommended, however, that in all cases for the frequencies used for communication between the user and a network access point the bandwidth should not exceed 12 kHz. For links between packet-radio nodes higher data rates and larger bandwidths may be used. For such high speed links ( greater than 1200 bit/s ) FM/AFSK is not preferred